

# AMENITY DECK PRODUCTS + CONSULTING



CATALOG 7

MUSC Children's Hospital

# GREENRISE TECHNOLOGIES

A total amenity space product provider, servicing all of the U.S. and Canada.

We are a consultant to architects, building owners, and general contractors for project specifications and design assistance.

Let our expertise and knowledge guide you toward a successful project!







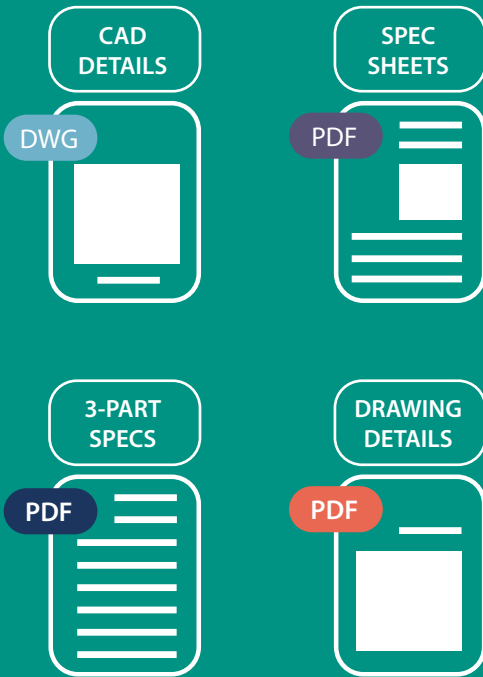

Now offering Accredited AIA CEU & LA CES courses on our website, by video conference or in-office presentations.



Visit our website for a complete library of specifications and product downloads



## Our primary clients are:

-  Office
-  Hotel
-  Education
-  Government
-  Commercial
-  Healthcare
-  Industrial
-  Multi-Family



“

We were extremely pleased with the green roofs that Greenrise provided and installed at two of the offices we recently developed, that we have asked them to provide a green wall for another project.

”

Ravenclyff – Michael Woody, Developer

**GRO VISTA MODULES  
WITH SEDUM TILES/MATS**

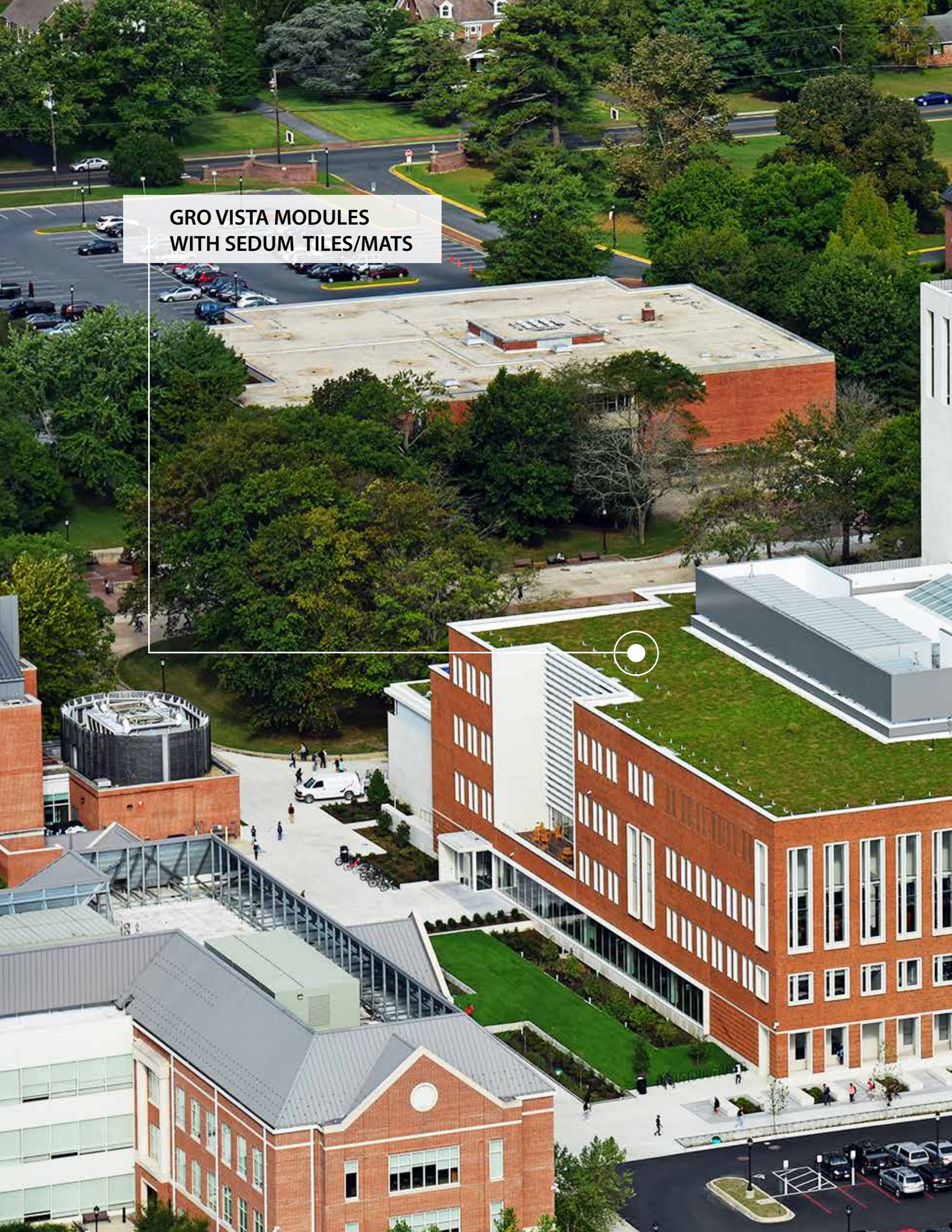



# SALISBURY UNIVERSITY

# MOTLEY RICE OFFICE BUILDING

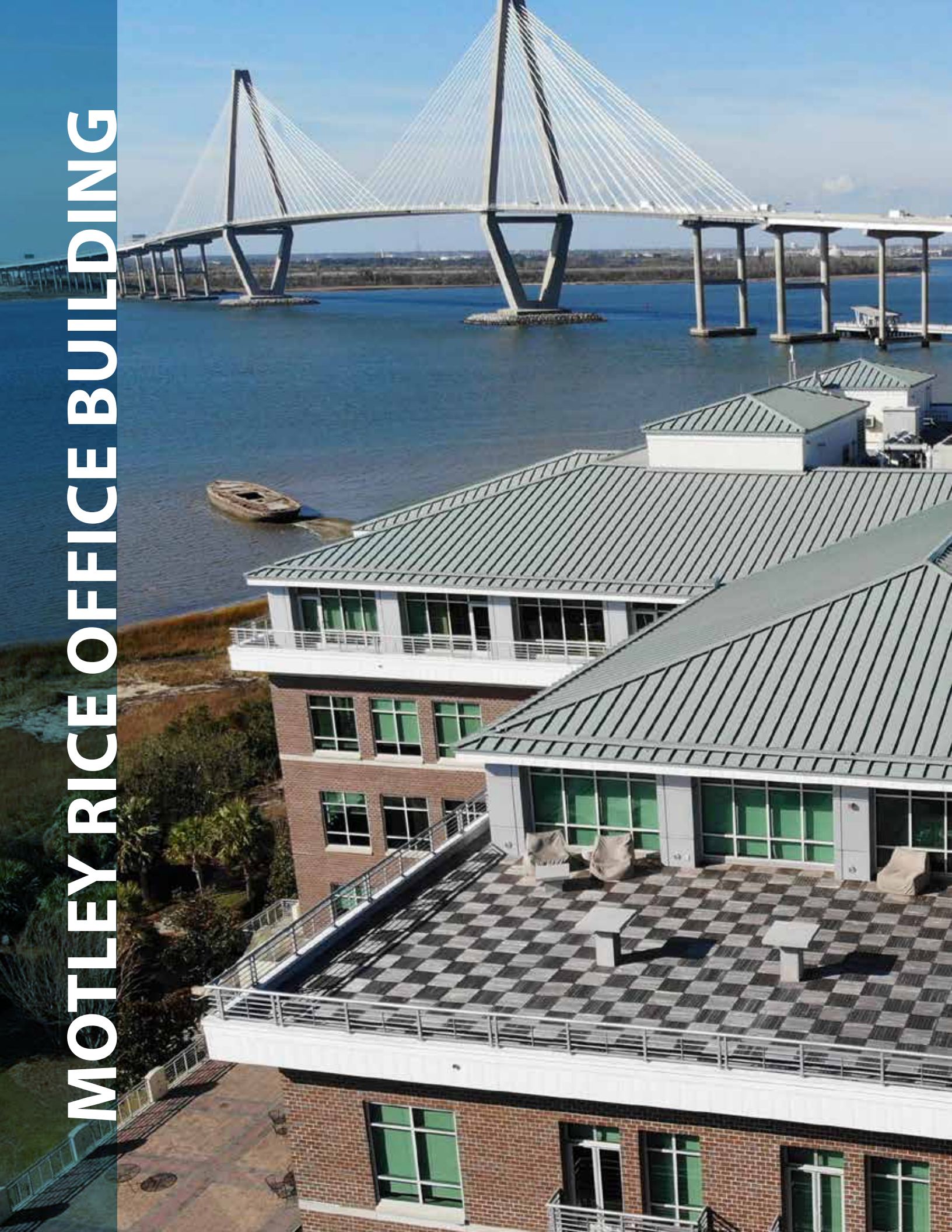



**IPE TILES & PEDESTALS**



**LAYERED SYSTEM WITH  
WIND UPLIFT & SLOPE  
COMPONENTS**





UNIVERSITY OF MIAMI

# INCYTE PHARMACEUTICAL

ARTIFICIAL TURF





**EXTENSIVE & INTENSIVE  
LAYERED SYSTEMS**

**IPE DECK BOARDS**

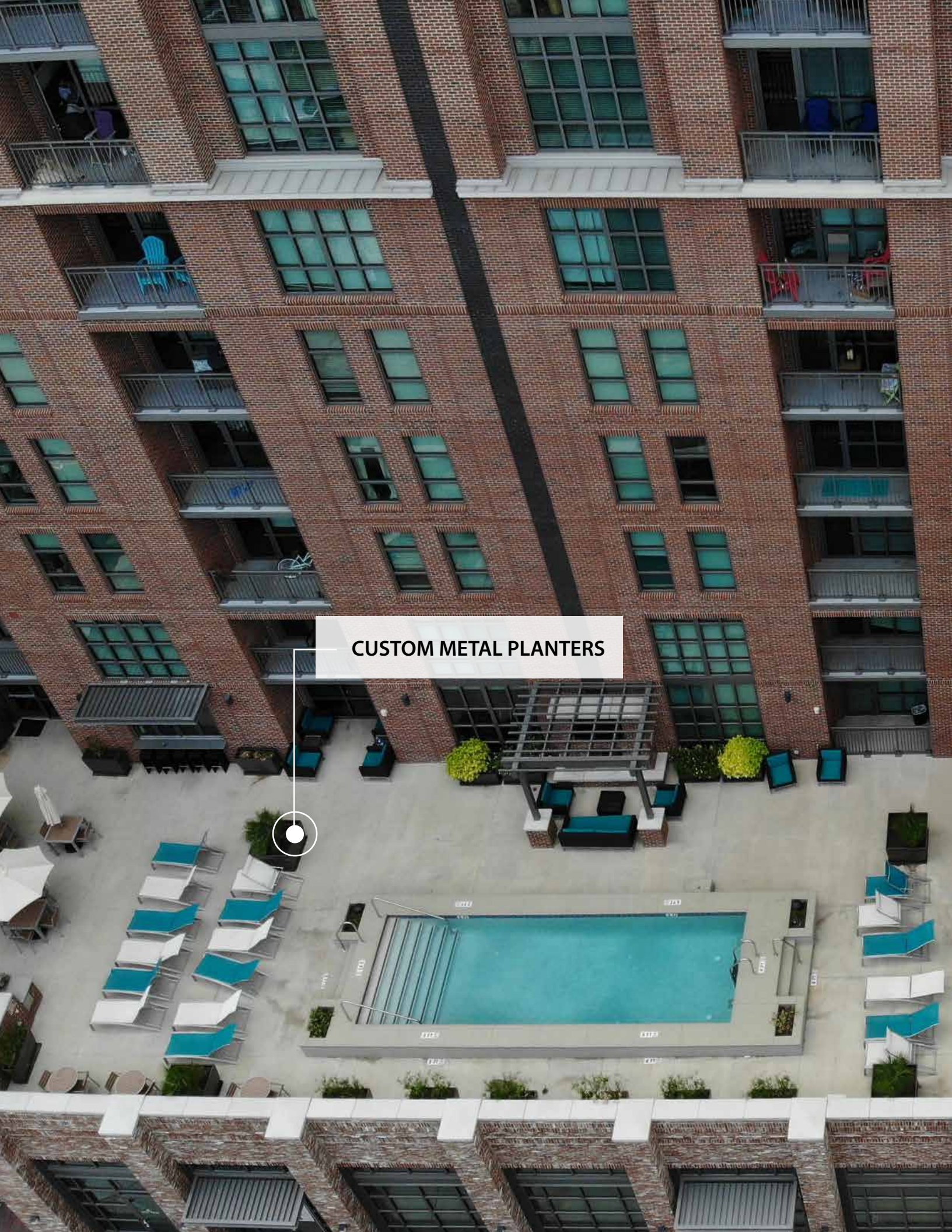

CUSTOM METAL PLANTERS

# WOOLFE STREET APARTMENTS

GRO VISTA MODULES  
WITH CUSTOM PLANTS

CONCRETE  
CURB EDGING



# TRU HOTEL BY HILTON



IPE DIMENSIONAL LUMBER

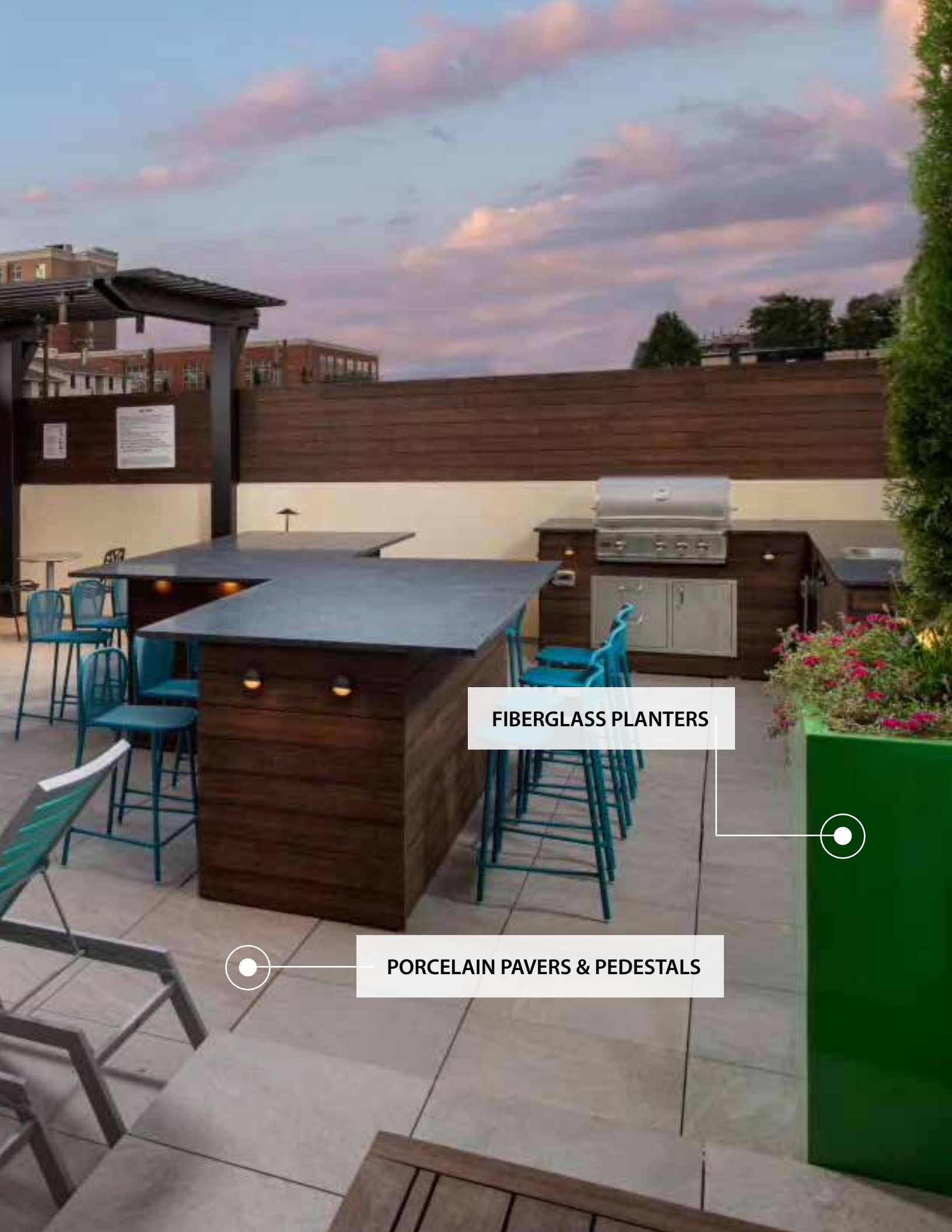

**FIBERGLASS PLANTERS**

**PORCELAIN PAVERS & PEDESTALS**



**INTENSIVE LAYERED SYSTEMS**

**CUSTOM METAL PLANTERS**



# PINNACLE FINANCIAL PARTNERS

EXTENSIVE LAYERED SYSTEMS



# THE DEWBERRY HOTEL

IPE TILES & PEDESTALS





“

I am amazed by how fast the GRO's green roof system was installed. Everyone was flexible to fit into a tight timeline, which was so important for site scheduling. The green roof looked complete from day one!

”

Sharp & Diamond Landscape Architecture –  
David Stoyko, Landscape Architect



# TABLE OF CONTENTS

---



**Green Roofs**..... 1  
Modular  
Layered



**Green Roof & Blue Roof Components**.....7  
Drain Mats  
Root Barriers  
Filter Fabric  
Capillary Mat  
Mineral Wool  
Drain Covers  
Metal Edging  
Concrete Curb Edging  
Plants & Soil  
Stormwater Detention Modules



**Deck Pavers & Pedestal Systems**.....21  
Concrete Pavers  
Ipe (and other hardwoods) Tiles  
Wood Deck Tile Fastening Kits  
Porcelain Pavers  
Paver Grate  
Paver Grate Fastening Kit  
Pedestals



**Artificial Turf**.....34  
Artificial Turf



**Wind Uplift & Erosion Control Solutions**.....36  
Vegetated Wind Uplift & Erosion Control Kit  
Erosion Control Blanket & Wind Uplift Mat  
Ballast Grid  
Structural Grate  
Structural Grate Fastening Kits



**Green Walls & Fences**.....42  
Living Walls  
Artificial Walls  
Living Fences



**Planters**.....48  
Fiberglass  
Aluminum / Stainless / Corten  
Concrete

\*Minimum product specs shown in catalog. Go to [www.greenrisetech.com](http://www.greenrisetech.com) for full specifications.

# LAYERED vs. MODULAR

There are several key differences between layered and modular green roof systems.

In a **layered system**, the depth of the growing media is customizable and can accommodate a variety of small to large sized vegetation, including trees.

This allows for unlimited design options, including amenity rooftop decks, and opportunities for increased biodiversity and stormwater detention and retention.

### LAYERED SYSTEM

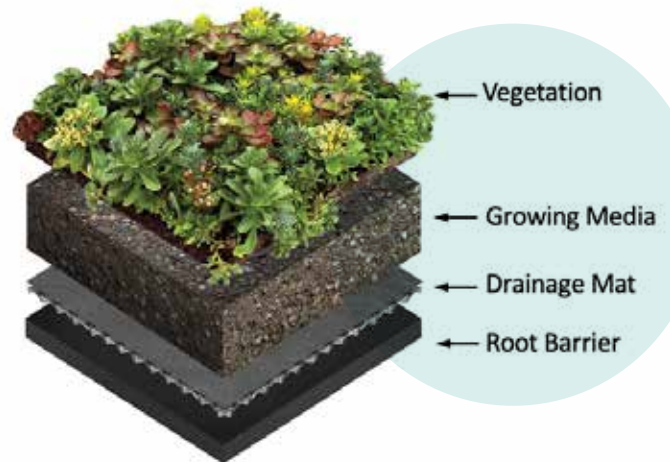

In a **modular system**, the trays are pre-assembled with growing media and low maintenance, drought tolerant plants. The vegetative trays are placed on the roof in configured designs, and often require less expertise for installation.

### MODULAR SYSTEM

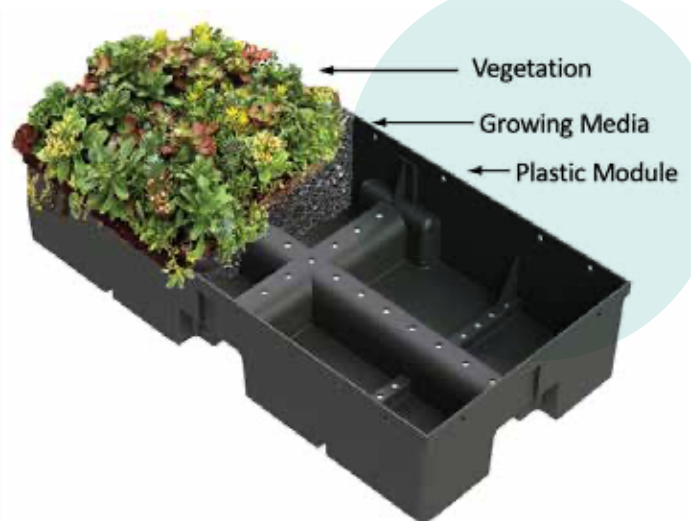



<b>DESCRIPTION</b>	<b>LAYERED</b>	<b>MODULAR</b>
	COMPONENTS ARE LAYERED AND BUILT IN PLACE ON THE ROOF	COMPONENTS PRE-ASSEMBLED IN PLASTIC TRAYS FOR PLACEMENT ON ROOF
AVAILABLE DEPTHS	ALL DEPTHS	4", 6", & 8"
GROWING MEDIA	EXTENSIVE OR INTENSIVE	EXTENSIVE OR INTENSIVE
SYSTEM WEIGHT	FULLY ADJUSTABLE	PREDETERMINED
WATER RETENTION CAPACITY	FULLY ADJUSTABLE	PREDETERMINED
DESIGN CONFIGURATIONS	UNLIMITED	SOMEWHAT LIMITED
PLANT OPTIONS	UNLIMITED	SEDUMS & GRASSES TYPICAL
EDGING	REQUIRED	OPTIONAL
IRRIGATION REQUIRED	YES / RECOMMENDED	YES / RECOMMENDED
SYSTEM PARTS (# REQUIRED)	4 PLUS	ALL IN ONE
ASSEMBLY REQUIRED	YES	NO
USE ON STEEP SLOPED ROOFS (> 4:12)	YES	NO
USE ON RETROFIT ROOFS	YES	YES
MAINTENANCE REQUIRED	YES	YES
WATERPROOFING MEMBRANE REQ./TYPE	YES / ANY	YES / ANY
REMOVAL FOR ROOF MAINTENANCE	DIFFICULT	EASY
COST COMPARISON	PROJECT DEPENDENT / APPROX. EQUAL	PROJECT DEPENDENT / APPROX. EQUAL
<b>INSTALLATION</b>		
EXPERTISE REQUIRED	YES	NO
CURVED AREAS	EASY	DIFFICULT
ADJACENT TO DECKING	EASY	EASY
URBAN LOGISTICS	CRANE (TYP.)	CRANE/ELEVATOR/ STAIRS

# Green Roofs

MODULAR SYSTEMS







The GRO Vista modular series and GRO layered green roof systems are the next generation of vegetated systems and are ALWAYS EVOLVING ... their features are based on continuous feedback and updates from code officials, stormwater regulations, designers, and installers across North America. The GRO Vista modular design combines total stormwater control with cost effective installation.

**\*\*\*Contact us for assistance in selecting which system is best suited for your project needs\*\*\***

## Modular | GRO VISTA Series



Features of the GRO Vista modular series include: recycled plastic, built-in reservoirs, irrigation channels, inset handles, root-aeration vents, corner extensions for no soil-loss gaps, and sidewall gussets for added strength.

ITEM	H <sub>2</sub> O RETENTION*	SATURATED WEIGHT	WATER DISPERSAL	DEPTH	COST
------	-----------------------------	------------------	-----------------	-------	------

### GRO VISTA 4" LITE MODULE

Vegetation (sedum tiles/plugs) 3.5" Lt. Wt. Ext. Engineered Soil 12" x 24" x 4"	1.1 gal/sf	20 psf	12 gal/min/lf	4"	\$\$
---	------------	--------	---------------	----	------

The GRO VISTA 4" LITE modular system is the answer for weight-sensitive projects, in one easy to install package.

### GRO VISTA 4" MODULE

Vegetation (sedum tiles/plugs) 4" Ext. Engineered Soil 12" x 24" x 4"	1.35 gal/sf	28 psf	12 gal/min/lf	4"	\$
---	-------------	--------	---------------	----	----

The GRO VISTA 4" modular system is the optimal balance for weight restrictions, low-cost, and stormwater retention, in one complete system.

### GRO VISTA 6" & 8" MODULES

Vegetation (Ext./Int. Plants) 6"- 8" Ext./Int. Engineered Soil 12" x 24" x 6" or 8"	1.9 - 2.6 gal/sf	35-55 psf	12 gal/min/lf	6" - 8"	\$\$\$
---	------------------	-----------	---------------	---------	--------

The GRO VISTA 6" & 8" modular systems offer the solution for maximum stormwater capture and the most flexibility for plant selection.

\*H<sub>2</sub>O retention numbers includes estimated retention by vegetation

### Layered | GRO Series

The GRO Series layered system design offers a balance between weight and stormwater control and has customizable component options to meet specific project requirements. Features include: sedum tiles or plugs, extensive or intensive engineered soil, drainage mat, optional mineral wool for increased stormwater retention/detention, and root barrier.

**\*\*\*Contact us for assistance in selecting which system is best suited for your project needs\*\*\***

ITEM	H <sub>2</sub> O RETENTION**	SATURATED WEIGHT	IRRIGATION	DEPTH	COST
------	------------------------------	------------------	------------	-------	------

#### GRO FEATHERWEIGHT

Vegetation (sedum tiles/plugs)					
2" Lt. Wt. Ext. Engineered Soil*	.66 gal/sf	17 psf	Required	2.5"	\$
0.5" Drain Mat					
Root Barrier (as required)					

The GRO Featherweight system is a novel solution for projects that have weight constraints or value engineered (VE) budgets.

The engineered soil composition is slightly higher in organic additives than typical extensive systems, to allow a sufficient nutrient base in a thin profile. Irrigation is highly recommended for this system.

#### GRO 2 + 1

Vegetation (sedum tiles/plugs)					
2" Ext. Engineered Soil*	1.3 gal/sf	25 psf	Recommended (site specific)	3.5"	\$\$
1" Mineral Wool					
0.5" Drain Mat					
Root Barrier (as required)					

The GRO 2+1 is the perfect balance of maximum water retention within a lower-weight system.

This synergy of engineered soil and premium mineral wool allows the system to work in harmony and provide the vegetation with needed nutrients and aeration, while retaining as much stormwater as a standard 4" deep layered system.

\*soil depths can be customized

\*\*H<sub>2</sub>O retention numbers includes estimated retention by vegetation



ITEM	H <sub>2</sub> O RETENTION**	SATURATED WEIGHT	IRRIGATION	DEPTH	COST
------	------------------------------	------------------	------------	-------	------

### GRO CLASSIC



Vegetation (Ext./Int. Plants) 4" Ext./Int. Engineered Soil* 0.5" Drain Mat Root Barrier (as required)	1.3 gal/sf	33 psf	Recommended (site specific)	4.5"	\$
--	------------	--------	--------------------------------	------	----

The GRO Classic is a cost effective system that meets minimum depths and stormwater retention requirements for most U.S. cities.

This 'tried & true' standard of the green roof industry has been proven for many years, and will continue to be specified.

### GRO WATERHOG



Vegetation (sedum tiles/plugs) 4" Ext./Int. Engineered Soil* 1" High Retention Drain Mat Root Barrier (as required)	1.7 gal/sf	37 psf	Recommended (site specific)	5"	\$\$
--	------------	--------	--------------------------------	----	------

The GRO WaterHog is a premium, high performance system for stormwater management.

The GRO WaterHog has the infrastructure of the GRO Classic system, with the addition of a high-retention drainage mat, that provides almost 25% more retention than the Classic.

### GRO WATERHOG XL



Vegetation (sedum tiles/plugs) 4" Ext./Int. Engineered Soil* 1" Mineral Wool 1" High Retention Drain Mat Root Barrier (as required)	2.3 gal/sf	43 psf	As Needed (site specific)	6"	\$\$\$
---	------------	--------	------------------------------	----	--------

The GRO WaterHog XL is the standard WaterHog system with an additional 1" layer of premium mineral wool, which increases the retention capacity to over 50% above the Classic!

This is the system to choose when stormwater control is a priority.

# Components

## DRAIN MAT



### GRO DRAIN MAT PLUS | 0.5"

GRO Drain Mat Plus 0.5" is a double sided ½" thick drainage core with an extruded polymer matrix of tangled monofilaments, thermally bonded to spunbond fabric on one side and a non-woven fabric on the other side. This double-sided fabric drain mat can eliminate the need for an extra protection sheet for the roof's waterproofing system.

#### CORE SPECIFICATIONS

MATERIAL	Extruded Polymer
COMPRESSIVE STRENGTH	>30,000 psf (ASTM D1621 modified & ASTM D4716 (Flow rate may be decreased))
TRANSMISSIVITY	2 gpm/ft at .02 gradient

#### FABRIC SPECIFICATIONS

MATERIAL	Non-Woven and Spunbond Fabrics		
PUNCTURE STRENGTH	<u>NON-WOVEN</u> 70 lbs	<u>SPUN BOND</u> 35 lbs	<u>ASTM</u> D4833
PERMEABILITY	120 gal/min/ft <sup>2</sup>	185 gal/min/ft <sup>2</sup>	D4491



## GRO DRAIN MAT | 0.5"

GRO Drain Mat 0.5" is a 1/2" thick drainage core with an extruded polymer matrix of tangled monofilaments, thermally bonded to a non-woven geotextile and molded into waffle patterns. It provides excellent filtering performance, high tensile and tear strength, and is a functional and economic choice for use in typical layered systems.

### CORE SPECIFICATIONS

### FABRIC SPECIFICATIONS

MATERIAL	Extruded Polymer	MATERIAL	Non-Woven Geotextile
COMPRESSIVE STRENGTH	>30,000 psf (ASTM D1621 modified & ASTM D4716) (Flow rate may be decreased)	PUNCTURE STRENGTH	70 lbs (ASTM D4833)
TRANSMISSIVITY	2.1 gpm/ft at .02 gradient	PERMEABILITY	120 gal/min/ft <sup>2</sup> (ASTM D4491)

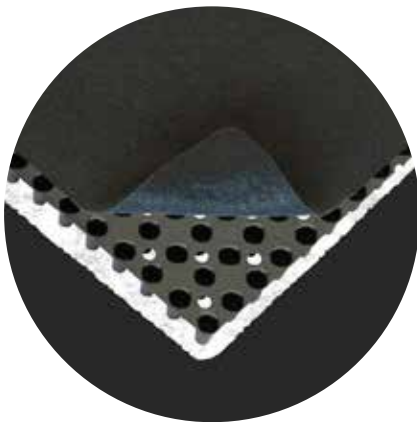

## GRO HIGH COMPRESSION MAT | 0.5"

GRO High Compression Drainage Mat 0.5" is a geocomposite drainage mat consisting of a polyethylene core, covered with a non-woven geotextile filter fabric on top, and a protection fabric on the bottom. The core of this drain mat offers high compression and stormwater retention, while permeable filter fabric prevents engineered soil from entering and blocking the core. This is for use with heavy loads, such as pavers and pedestals or concrete curbing.

### CORE SPECIFICATIONS

### FABRIC SPECIFICATIONS

MATERIAL	HDPE	MATERIAL	Non-Woven Geotextile
COMPRESSIVE STRENGTH	>10,000 psf (ASTM D1621 modified) (Flow rate not impacted)	PUNCTURE STRENGTH	70 lbs (ASTM D4833)
TRANSMISSIVITY	4.9 gpm/ft at .05 gradient	PERMEABILITY	120 gal/min/ft <sup>2</sup> (ASTM D4491)

# Components

## DRAIN MAT



### GRO LOW FLOW DRAIN MAT | 0.25"

GRO Low Flow Drain Mat 0.25" is a 1/4" thick drainage core with an extruded polymer matrix of tangled monofilaments, thermally bonded to a non-woven geotextile. With high tensile and tear strength, this drain mat provides additional stormwater detention time and slows the rate of stormwater flow to roof drains.

#### CORE SPECIFICATIONS

MATERIAL	Extruded Polymer
COMPRESSIVE STRENGTH	>30,000 psf (ASTM D1621 modified & ASTM D4716)
TRANSMISSIVITY	1 gpm/ft at .02 gradient

#### FABRIC SPECIFICATIONS

MATERIAL	Non-Woven Geotextile	
PUNCTURE STRENGTH	<u>NON-WOVEN</u> 70 lbs	<u>ASTM</u> D4833
PERMEABILITY	120 gal/min/ft <sup>2</sup>	D4491

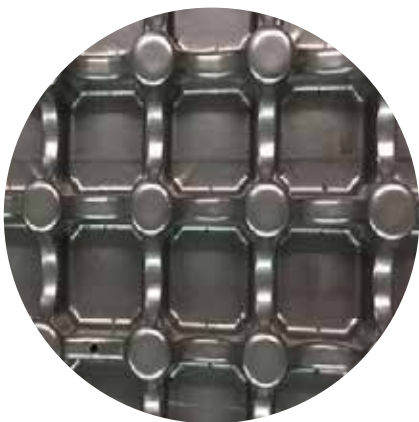

### GRO HIGH RETENTION DRAIN MAT | 1.0"

GRO High Retention Drain Mat is a 1.0" thick high-retention drainage panel made from 100% recycled high-density polypropylene. For use with green roof systems when maximizing water retention capacity is a priority. This drain mat must be used in conjunction with GRO Filter Fabric for green roof installations.

MATERIAL	100% Recycled High-Density Polypropylene
COMPRESSIVE STRENGTH	> 7,000 psf
WATER RETENTION	0.458 gal/ft <sup>2</sup> (ASTM E2398/E2398M)
ACCOMPANYING GRO PRODUCT	GRO Filter Fabric

## ROOT BARRIER



### GRO ROOT BARRIER 20

GRO Root Barrier 20 is a smooth polyethylene 20 mil geomembrane film that is the typical standard used in layered green roof systems. It is a protection layer, that aids in protecting the waterproofing system from plant root intrusion.



MATERIAL	Black Polyethylene Geomembrane
THICKNESS & WEIGHT	20 mil & 80 lbs/roll (Other thicknesses available upon request)
BREAK STRENGTH	42 lb/in (ASTM D6693 Type IV)
PUNCTURE RESISTANCE	36 lbs (ASTM D4833)

### GRO ROOT BARRIER 30

GRO Root Barrier 30 is a smooth HDPE 30 mil geomembrane film for use when required by municipalities or project specifications. It aids in protecting the waterproofing membrane from root intrusion from more aggressive/larger plants.



MATERIAL	Black Polyethylene HDPE
THICKNESS & WEIGHT	30 mil & 4,200 lbs/roll (ASTM D5199) (Other thicknesses available upon request)
BREAK STRENGTH	120 lb/in
PUNCTURE RESISTANCE	60 lbs (ASTM D4833)

# Components

## FILTER FABRIC



### GRO FILTER FABRIC

GRO Filter Fabric is a non-woven, needle punched geotextile separator for green roof systems. A permeable solution to prevent engineered soil from blocking drainage in a GRO Layered System or as an optional protection layer between a GRO Modular System and the roof's waterproofing membrane. GRO Filter Fabric allows water flow at 140 gallons per minute and is UV resistant.

MATERIAL	Polypropylene
DENSITY & WEIGHT	4 oz. & 114 lbs/roll
WATER FLOW	> 120 gal/min/ft <sup>2</sup> (ASTM D4491)
PERMITTIVITY	2.0 sec <sup>-1</sup> (ASTM D4491)

## CAPILLARY MAT



### GRO CAPILLARY MAT

GRO Capillary Mat is a thick geotextile mat made from mechanically consolidated, needle punched, fine-denier, polyester fibers. For use in horizontal and sloped green roof applications for additional water retention.

MATERIAL	Needle Punched Polyester Fibers
FABRIC WEIGHT	28 oz/yd <sup>2</sup> (ASTM D5261)
WATER RETENTION	0.1 gal/ft <sup>2</sup> (ASTM E2398)
SATURATION DENSITY	1.1 lb/ft <sup>2</sup> (ASTM E2398)



# MINERAL WOOL



## GRO MINERAL WOOL

GRO Mineral Wool is a lightweight and efficient stormwater retention product, with very high water retention capacity. For use below vegetation and soil layers, it is an engineered horticultural approach to stormwater management that provides maximum water retention with minimum weight.

MATERIAL	Mineral Wool
WET WEIGHT	4.9 lbs/ft <sup>2</sup> (ASTM E2397)
RETAINED WATER	0.54 gal/ft <sup>2</sup>
RETAINED WATER VOLUME	≥ 89%

# DRAIN COVERS AND LIDS



## GRO DRAIN COVERS and LIDS

GRO Drain Covers and Lids provide effective drainage and protection from debris entering the roof drains for rooftop decks and green roofs. Designed to be lightweight for rooftop applications, they provide a functional purpose with a polished look. All aluminum GRO Drain Covers and Lids are from made recycled aluminum, are 100% recyclable, and may qualify for LEED points.

MATERIAL	Aluminum: Extruded 6063 Alloy Plastic: Recycled Polypropylene
DIMENSIONS	Aluminum: 15" x 15" x 6" high (inside) Plastic: 15 3/16" x 15 3/16" x 6 1/2" high (inside) / Custom sizes available
FINISH	Aluminum: Mill Finish Anodized / Black DuraFlex Plastic: Black
SECURITY	2 piece with lockable lid



### GRO METAL EDGING

GRO Metal Edging is a strong yet lightweight, bendable restraint that provides a great finished look for both modular systems and layered green roof systems. GRO Metal Edging accommodates design curves and angles and is easy to install, making it a great alternative to structural curbing or as an edging detail for paver and tiles on rooftop walkways. Made from recycled aluminum, GRO Metal Edging is 100% recyclable and qualifies for LEED project points.



MATERIAL	Aluminum Extruded 6063 Alloy
DIMENSIONS	Varying heights 4.5", 6.5", & 8.25" heights x 8' lengths
FINISH	Mill Finish Anodized Black DuraFlex Coating available by special order
COMBUSTIBILITY	Extruded aluminum will not burn and does not emit any toxic, hazardous fumes when exposed to high temperatures
UV	Aluminum reflects ultraviolet radiation and is not damaged by harmful UV rays



## CONCRETE CURB EDGING

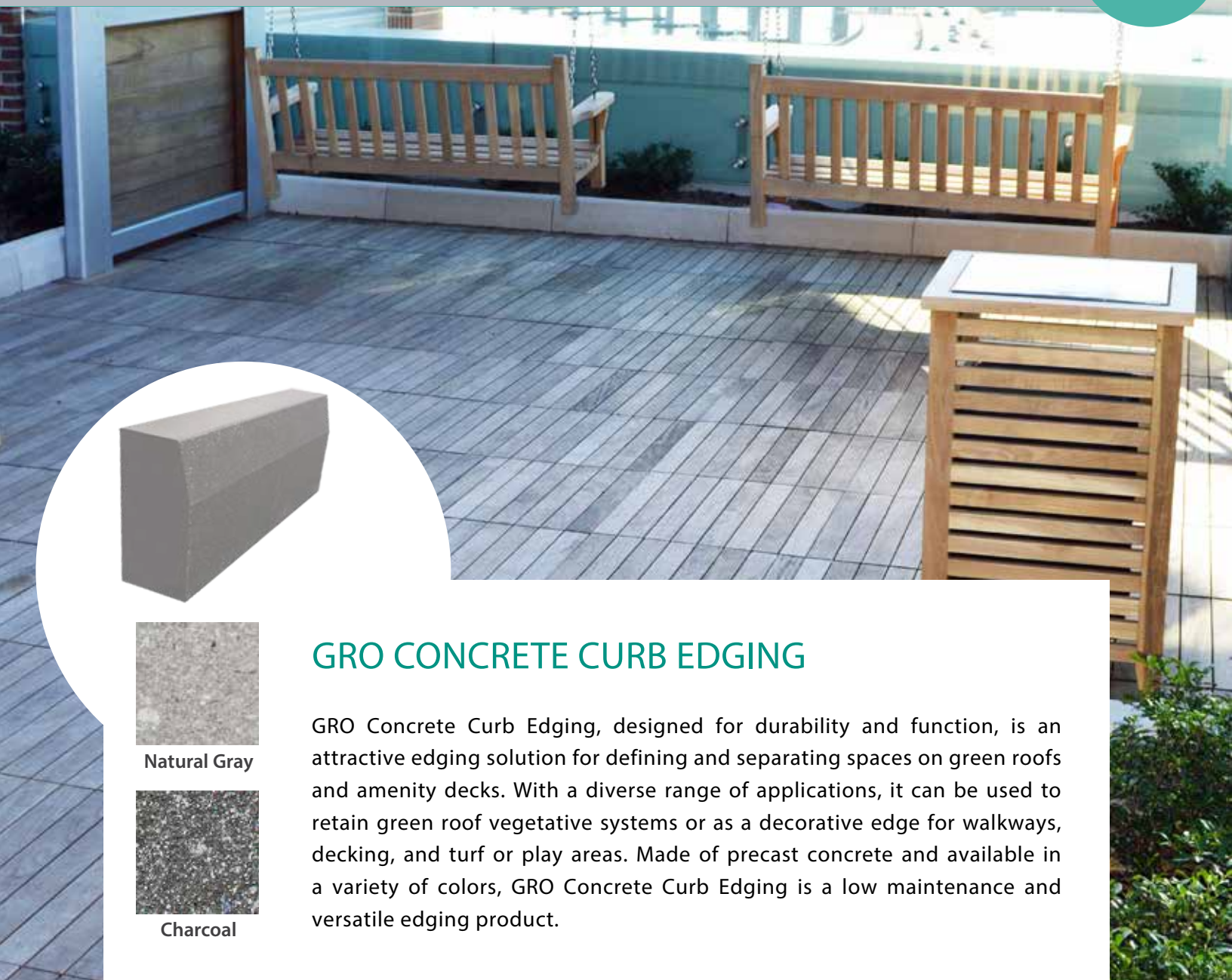

Natural Gray



Charcoal

### GRO CONCRETE CURB EDGING

GRO Concrete Curb Edging, designed for durability and function, is an attractive edging solution for defining and separating spaces on green roofs and amenity decks. With a diverse range of applications, it can be used to retain green roof vegetative systems or as a decorative edge for walkways, decking, and turf or play areas. Made of precast concrete and available in a variety of colors, GRO Concrete Curb Edging is a low maintenance and versatile edging product.

#### MATERIAL

Gray Cement, Crushed Limestone, Sand, Recycled Water  
Iron Oxide Coloring - if needed (ASTM C936)

#### DIMENSIONS

6" x 12" x 36" (actual) Beveled Curbs (ASTM C936)

#### WEIGHT

77 lbs/lf = 232 lbs/curb (ASTM C936)

#### COLORS

Natural Gray and Charcoal

#### COMPRESSIVE STRENGTH

8,000 psi minimum (ASTM C140)

# Components

## PLANTS



### GRO SEDUM TILES

GRO Sedum Tiles typically consist of at least 12 different sedum varieties, grown on 1" proprietary soil mix using the plant roots as the structural backing. GRO Sedum Tiles are designed for use in modular and layered green roof systems, planters, living walls, bioswales, and other stormwater management and green amenity applications.

#### SEDUM VARIETIES TYPICALLY INCLUDE AN ASSORTMENT OF:

Sedum acre 'Golden Carpet'	Sedum Hybridum
Sedum acre 'Octoberfest'	Sedum reflexum 'Blue Spruce'
Sedum albums (assorted)	Sedum Sediforme
Sedum Ellacombianum	Sedum Selksianum
Sedum floriferum 'Weihenstephaner Gold'	Sedum Sexangulare
Sedum Forsterianum 'Silver Stone'	Sedum spurium 'Coccineum'
Sedum Glaucophyllum	Sedum spurium 'Summer Glory'
Sedum Hispanicum	Sedum spurium 'Voodoo'

DIMENSIONS	12" x 24" x 1" (2 ft <sup>2</sup> )
SQ. FT. PER PALLET	240 ft <sup>2</sup>
DRY WEIGHT	1.5 lbs/ft <sup>2</sup>
WET WEIGHT	Approx. 2 lbs/ft <sup>2</sup>
WEIGHT PER PALLET	420 lbs



## GRO BULK ENGINEERED GREEN ROOF SOIL

GRO Engineered Green Roof Soil is a lightweight growing media designed for multi-layer green roof systems. It is a balanced blend of mineral aggregates and organic content, which helps to neutralize acid runoff and maintain pH levels and soil depth. For use in intensive, semi-intensive, and extensive vegetative roofs, GRO Engineered Green Roof Soil is blended and tested to ASTM standards. Available for delivery in bulk, super sacks, or cubic foot bags.

Blends may vary per geographic region and vegetative growing conditions.

### EXTENSIVE SOIL - MID ATLANTIC REGION (ASTM E2399)

WATER PERMEABILITY	Varies per blend
DRY WEIGHT	50 - 60 lb/ft <sup>3</sup>
MAX. SATURATED WEIGHT	68 - 88 lb/ft <sup>3</sup>
MAX. WATER RETENTION	44% - 53%
ORGANIC MATTER	7.6%



### INTENSIVE SOIL - MID ATLANTIC REGION (ASTM E2399)

WATER PERMEABILITY	Varies per blend
DRY WEIGHT	50 - 60 lb/ft <sup>3</sup>
MAX. SATURATED WEIGHT	75 - 93 lb/ft <sup>3</sup>
MAX. WATER RETENTION	48% - 55%
ORGANIC MATTER	7.3% - 7.6%



# Components

## STORMWATER DETENTION

### GRO 2" STORMWATER DETENTION MODULES

GRO 2" Stormwater Detention Modules are a lightweight, effective stormwater storage solution to maximize retention and /or detention. Each detention module is 2" thick, can be stacked up to 10' high, and easily configured for efficient use of space. Designed as an open shell, these modules encourage infiltration with 90% internal and surface void area available for high capacity stormwater capture. Typically installed with GRO Filter Fabric and GRO Root Barrier.



Stormwater Detention .48  
.48 to 28.8 cf

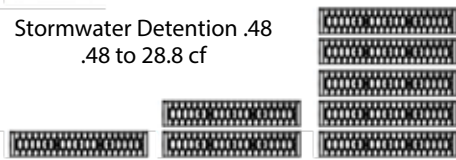

Before



After



#### MATERIAL

100% Recycled Polypropylene

#### MODULE DIMENSIONS & WEIGHT

20" x 24" x 2" (nominal); 4 lbs.  
19.68" x 23.62" x 1.97" (actual); 4 lbs.

#### MODULE STACKING

Maximum 10' = 60 layers

#### AREA VOLUME & WATER CAPACITY

0.53 cf & 0.48 cf

#### VOID AREA

90% volume available for water storage

#### COMPRESSIVE STRENGTH

240.2 psi (ASTM D 2412 / ASTM F2318)



Stormwater Detention  
2.3 to 27.6 cf

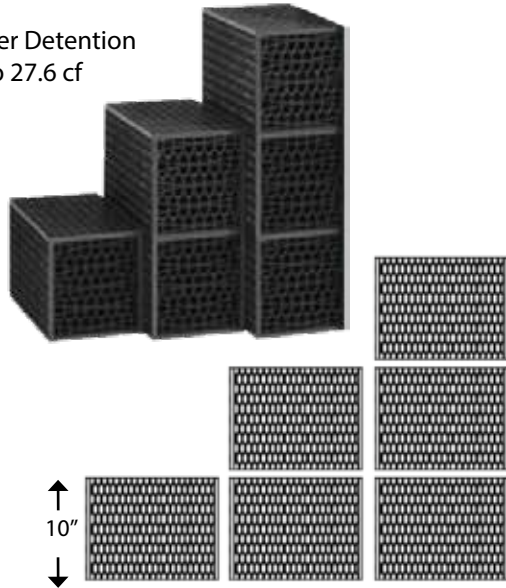

## GRO 10" STORMWATER DETENTION MODULES

GRO 10" Stormwater Detention Modules are an efficient and versatile stormwater storage solution to maximize retention and/or detention for blue roof projects. Each detention module is 10" thick and can be stacked up to 10' high. Designed as an open shell, these modules encourage infiltration and have 95% volume available for stormwater capture. Ideal for green space applications, GRO Stormwater Detention Modules are easily configured for efficient use of space and are lightweight for ease of installation. Typically installed with GRO Filter Fabric and GRO Root Barrier.

Before

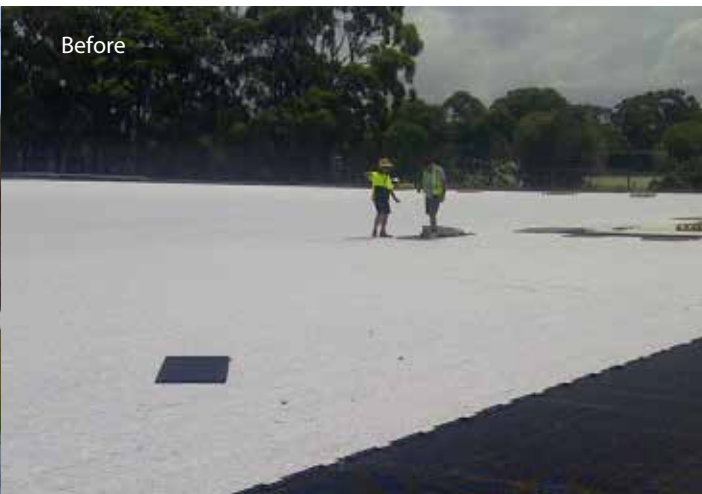

After



### MATERIAL

100% Recycled Polypropylene

### MODULE DIMENSIONS & WEIGHT

16" x 28" x 10" (nominal); 10.1 lbs.  
15.75" x 28.15" x 9.45" (actual); 10.1 lbs.

### MODULE STACKING

Maximum 10' = 12 layers

### AREA VOLUME & WATER CAPACITY

2.42 cf & 2.30 cf

### VOID AREA

95% volume available for water storage

### COMPRESSIVE STRENGTH

30 psi (ASTM D2412 / ASTM F2318)

# Deck Pavers & Pedestal Systems

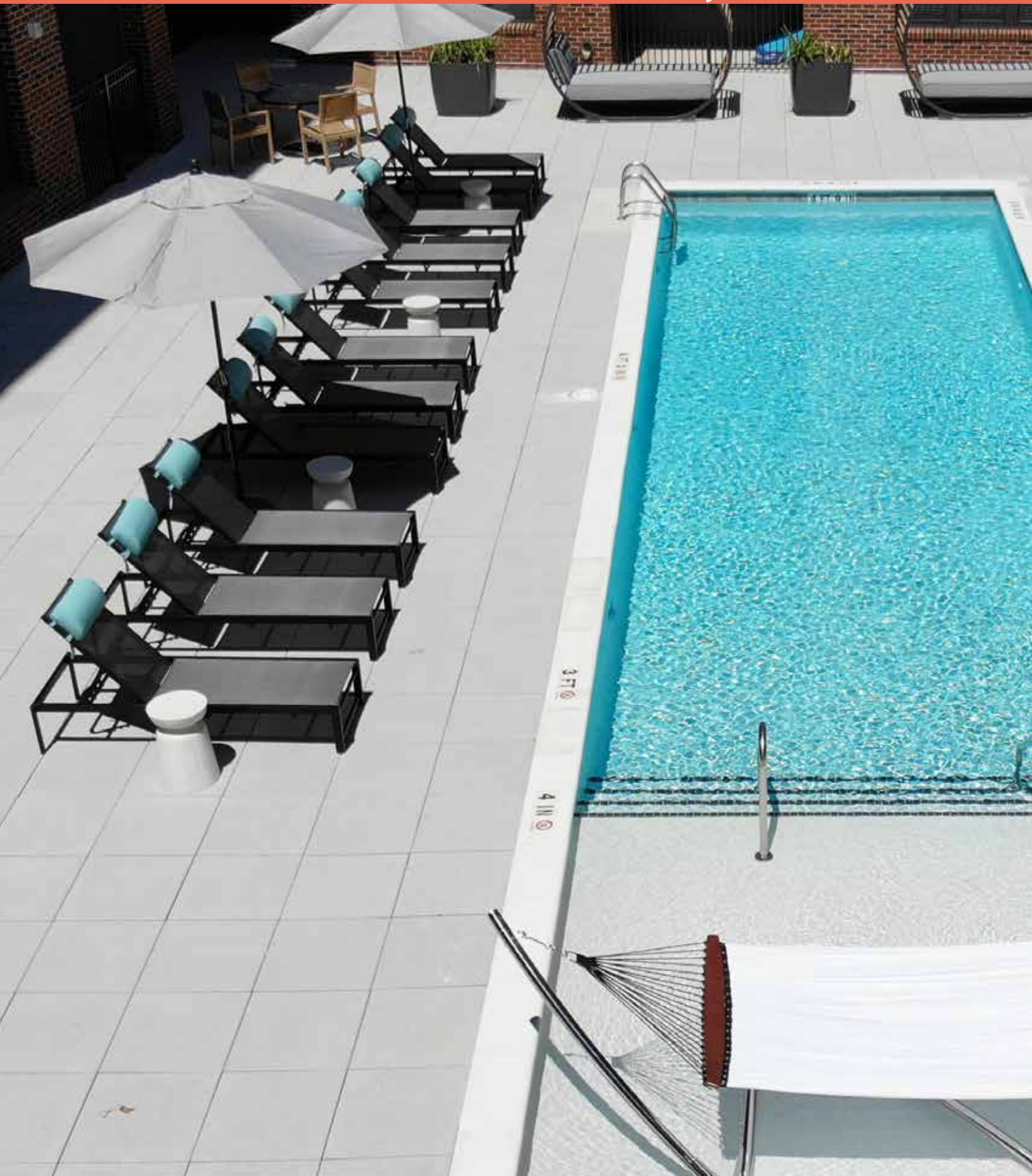





# Deck Pavers & Pedestal Systems

## COLORS & FINISHES

### NATURAL GRAY - Shotblast, Diamond, & Matte Finish



PA -17



PA -17D



PA -17M

### STANDARD COLORS - Shotblast Finish



PA -14



PA -16



PA -18



PA -110



PA -113

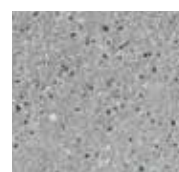

PA -123



PA -127



PA -131



PA -132



PA -150



PA -158



PA -160



PA -161



PA -162



PA -163



PA -166



PA -168



PA -179

### PREMIUM COLORS - Shotblast Finish



PA -11



PA -12



PA -129



PA -145



PA -153

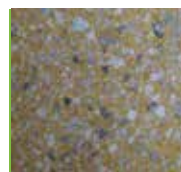

PA -165



PA -171



PA -175



PA -178



PA -189



## GRO CONCRETE PAVERS

GRO Concrete Pavers, designed for durability and stability, are an attractive and functional hardscaping option for creating gathering spaces or adding walking paths to patios, terraces, and rooftop areas. When installed with GRO Pedestals, these pavers offer a practical way to hide and protect roof penetrations, pipes, and uneven surfaces. GRO Concrete Pavers are available in a variety of aesthetic colors, textures, and sizes, and are A MADE IN THE USA product.

<p><b>DIMENSIONS</b></p>	<p>24" x 24" x 2" (actual)                  24" x 36" x 2" (actual) *Available by special order                  18" x 36" x 2" (actual) *Available by special order</p>
<p><b>WEIGHT</b></p>	<p>24" x 24" x 2" = 98 lbs.                  24" x 36" x 2" = 147 lbs.                  18" x 36" x 2" = 110 lbs.</p>
<p><b>COLORS &amp; FINISHES</b></p>	<p>Diamond or Matte Finish in Natural Gray Only                  Shotblast Finish (Tudor Equiv.) in Colors Shown                  Pigment conforming to ASTM C979</p>
<p><b>COMPRESSION STRENGTH</b></p>	<p>Average of 55 MPa (8500 psi); with no individual unit &lt; 50 MPa</p>
<p><b>FLEXURAL STRENGTH</b></p>	<p>870 PSI (NCMA testing procedures min. req. strength 650 psi)</p>

## GRO TRUNCATED DOME PAVERS (ADA)

GRO Truncated Dome Pavers have a distinctive textured surface that alerts pedestrians that they have stepped onto different terrain or a change in the landscape is near. Available in 4 standard colors (custom colors available upon request), these attractive pavers are suitable for a decorative addition around pool areas, rooftop walkways, and other transitional spaces. GRO Truncated Dome Pavers are fully compliant with the Americans With Disabilities Act and are A MADE IN THE USA product.



# Deck Pavers & Pedestal Systems

## WOOD TILES



### GRO CUMARU TILES

GRO Cumaru Wood Deck Tiles for use in both flat and sloped roof applications, terraces, plazas, and patios are designed to be used with fixed or adjustable height pedestals. Like GRO IPE Deck Tiles, GRO Cumaru Deck Tiles are structural tiles made from choice South American hardwood slats and secured to three solid wood support battens with stainless steel screws. GRO Cumaru Wood Deck Tiles provide durability and hardness, and are a good Value Engineered (VE) option for South American hardwood applications.



#### DIMENSIONS

24" x 24" x 1<sup>5</sup>/<sub>8</sub>"(nominal); 23 <sup>7</sup>/<sub>8</sub>" x 23 <sup>7</sup>/<sub>8</sub>" x 1<sup>1</sup>/<sub>2</sub>"(actual)

#### WEIGHT

23.5 lbs.

#### COLOR / GRAIN

Golden tan to dark reddish brown with dark grain accents

#### CHARACTERISTICS

Resists termites, fire, decay, and mold  
Low maintenance and wear and scuff resistant  
Very hard and dense

#### ACCOMPANYING GRO PRODUCTS

GRO PEDESTALS and GRO WOOD DECK TILE FASTENING KITS



## WOOD TILES

### GRO IPE TILES

GRO IPE Wood Deck Tiles are structural deck tiles designed to be used with fixed and adjustable height pedestals on both flat and sloped roof decks, terraces, plazas, or patios. IPE is one of the most commonly used South American hardwoods for outdoor decking. When accompanied with GRO Fasteners, the deck tiles can be locked down to the pedestals to mitigate wind uplift and to create a secure system. Alternatively, GRO IPE Wood Deck Tiles can also be laid over existing concrete or decks using fixed height spacer shims to lift the tiles off the surface and to ensure good drainage. GRO IPE Wood Tiles can be FSC®-C108155 certified upon request and GRO is a FSC® certified company.



#### DIMENSIONS

24" x 24" x 1 5/8" (nominal); 23 7/8" x 23 7/8" x 1 1/2" (actual)  
 24" x 48" x 1 5/8" (nominal); 23 7/8" x 47 7/8" x 1 5/8" (actual)  
 Custom sizes also available

#### WEIGHT

24" x 24" = 23.5 lbs; 24" x 48" = 48.5 lbs.

#### COLOR / GRAIN

Reddish brown color, variations from olive brown to black striping

#### CHARACTERISTICS

Resists termites, fire, decay, and mold  
 Low maintenance and wear and scuff resistant

#### ACCOMPANYING GRO PRODUCTS

GRO PEDESTALS and GRO WOOD DECK TILE FASTENING KITS

# Deck Pavers & Pedestal Systems

## WOOD TILES



### GRO FSC® ITAUBA TILES

GRO FSC® Itauba Wood Deck Tiles are structural deck ties designed for both flat and sloped roof areas, decks, plazas, or patios. GRO FSC® Itauba Wood Tiles look similar to Ipe and are a good Value Engineered (VE) replacement option. When supported with GRO Fixed Pedestals, both height and slope adjustments can be made easily and in small or large increments. In decking applications, incorporating GRO Fasteners can help mitigate wind uplift and movement and create a secure system. Made from choice South American hardwood, the tiles are comprised of slats secured to three solid wood support battens with stainless steel screws. GRO FSC® Itauba Wood Tiles are FSC® certified and GRO is an FSC® certified company.



#### DIMENSIONS

24" x 24" x 1 1/2" (nominal); 23 7/8" x 23 7/8" x 1 5/8" (actual)

#### WEIGHT

23.5 lbs.

#### COLOR / GRAIN

Typically yellow brown to dark lustrous brown

#### CHARACTERISTICS

Resists termites, fire, decay, and mold  
Low maintenance and wear and scuff resistant  
Resists bending, shearing, warping, and twisting

#### ACCOMPANYING GRO PRODUCTS

GRO PEDESTALS and GRO WOOD DECK TILE FASTENING KITS



## WOOD TILE FASTENING KITS

### GRO WOOD DECK TILE FASTENING KITS

GRO Fastening Kits for use with GRO Wood Deck Tiles provide a secure connection between pedestals and the finished deck surface. The weight of the deck pavers create a monolithic system to hold the system in place and mitigate against wind uplift. GRO offers 2 fastening kit options for wood deck tile projects; choice of fastening kit is based on pedestal heights.

#### SCREW & WASHER

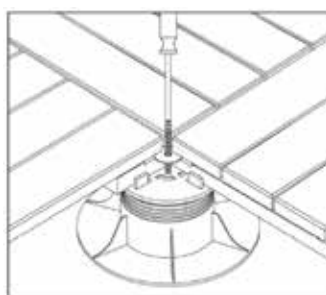

**For pedestal heights > 2.5"**  
**Easily removable for repairs and maintenance**

GRO Wood Deck Tiles are engineered with a slot cut in each corner enabling a special washer and finishing screw to be inserted. Once all tiles are in place, the washer and screw are invisibly screwed into the corresponding top of the pedestal to "lock down" the tiles, ensuring a safe, secure, and level surface. Our fastening kit makes removal of a centrally-located tile simple, and eliminates the need to remove all tiles from the perimeter up to that point.

#### **Fastening kit pedestal height > 2.5" installation:**

Three wooden deck tiles are placed on a pedestal. The screw and washer is placed into the fastening slot of each wood deck tile. The fourth deck tile is placed on the pedestal and the screw is fastened down to lock the wood deck tiles in place.

#### PLASTIC PINS

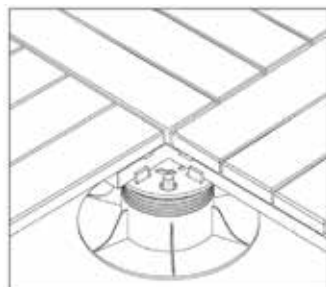

**For pedestal heights < 2.5"**  
**More permanent connection**

GRO Wood Deck Tiles have a connection hole in the bottom corners of the pavers to secure a plastic pin which provides a connection to the pedestals. Once all tiles are in place, the plastic pins are invisible, and ensure a safe, secure, and level surface. With our plastic pin fastening kit, removal of tiles for repairs and maintenance is simple and straightforward.

#### **Fastening kit pedestal height < 2.5" installation:**

Align the holes on the underside of the wood deck tiles with the plastic pins in the pedestals. Push down on tiles until connection is complete.

# Porcelain Pavers

## COLORS & FINISHES

### BLUESTONE



Tumbled Bluestone



Thermal Bluestone

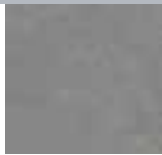

Bluestone Blue Select

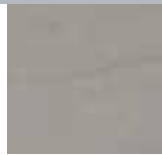

Thermal Bluestone Full Color

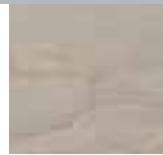

Bluestone Full Color

### FLAGSTONE



Flagstone Pink-Tan



Flagstone Brown



Multicolored Gold



Multicolored Dark



Vintage Slab

### TRAVERTINE



Travertine Cross Cut Noce



Travertine Cross Cut Silver



Travertine Cross Cut



Travertine Cross Cut White



Source Beige

### QUARTZ



Silver Quartz



Barge Gold



Pietra Di Barge



Point Silver

### LIMESTONE



Limestone

### CONCRETE



Simply Grey



Warm Sand



Freedom White



Passion Silver

### MARBLE



Michelangelo Extra White

### STONE

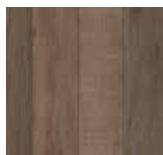

Walnut



Pepper



Soul Walnut



Soul Grey



Essence Grey



Essence Brown

### WOOD



Natural Ivory



Modern Grey



Pietra Di Bagnolo



Desert



Cosmos



Absolute



Sky





## PORCELAIN PAVERS

### GRO PORCELAIN PAVERS

GRO Porcelain Pavers can be used to create patio, terrace, and gathering spaces or to add walking paths to rooftop areas. Made for outdoor use, these pavers are slip, chemical, and fade resistant, and a no maintenance product. When installed on GRO Pedestals they offer a practical way to hide and protect roof penetrations, pipes, and uneven surfaces. GRO Porcelain Pavers are available in a variety of aesthetic colors, textures, and sizes, and are a MADE IN THE USA product.

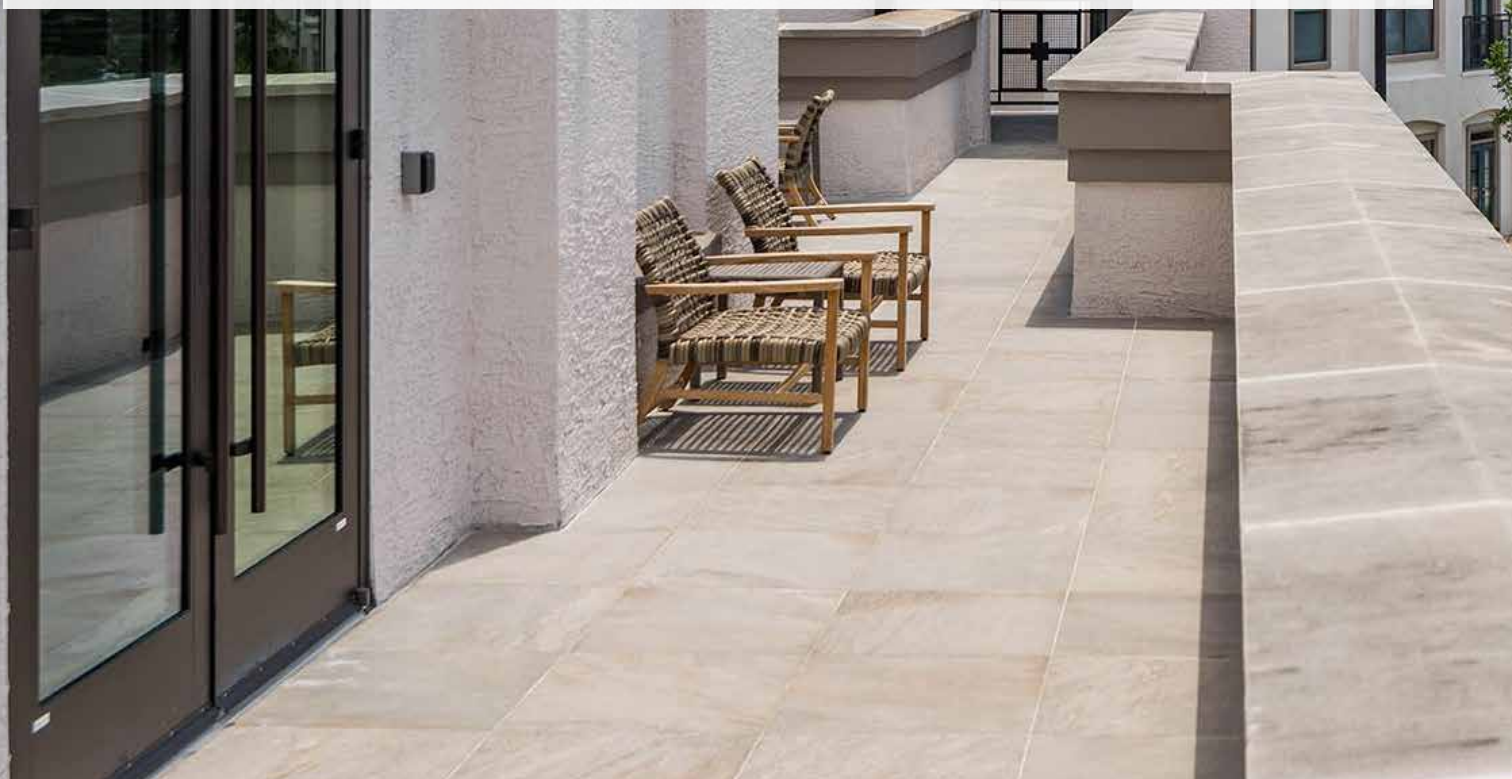

#### DIMENSIONS

24" x 24" x 3/4" (nominal); 23 1/2" x 23 1/2" x 3/4" (actual)

#### WEIGHT

25 lbs.

#### FREEZE / THAW

Resistant (ASTM C1026)

#### BREAKING STRENGTH

≥ 250 lbf (ASTM C648)

#### ACCOMPANYING GRO PRODUCTS

GRO PEDESTALS, GRO PAVER GRATE & FASTENING KIT

# Porcelain Pavers

## PAVER GRATE



Grate on GRO Pedestals with Porcelain Paver

### GRO PAVER GRATE

GRO Paver Grate enhances impact resistance for porcelain pavers in pedestal applications. It also provides a structural surface for loose laid pavers on deck pedestals. Engineered to attach to the pedestals, the GRO Paver Grate creates a stable and secure foundation and mitigates wind uplift resistance. Multiple options are available for adhesion to porcelain pavers.

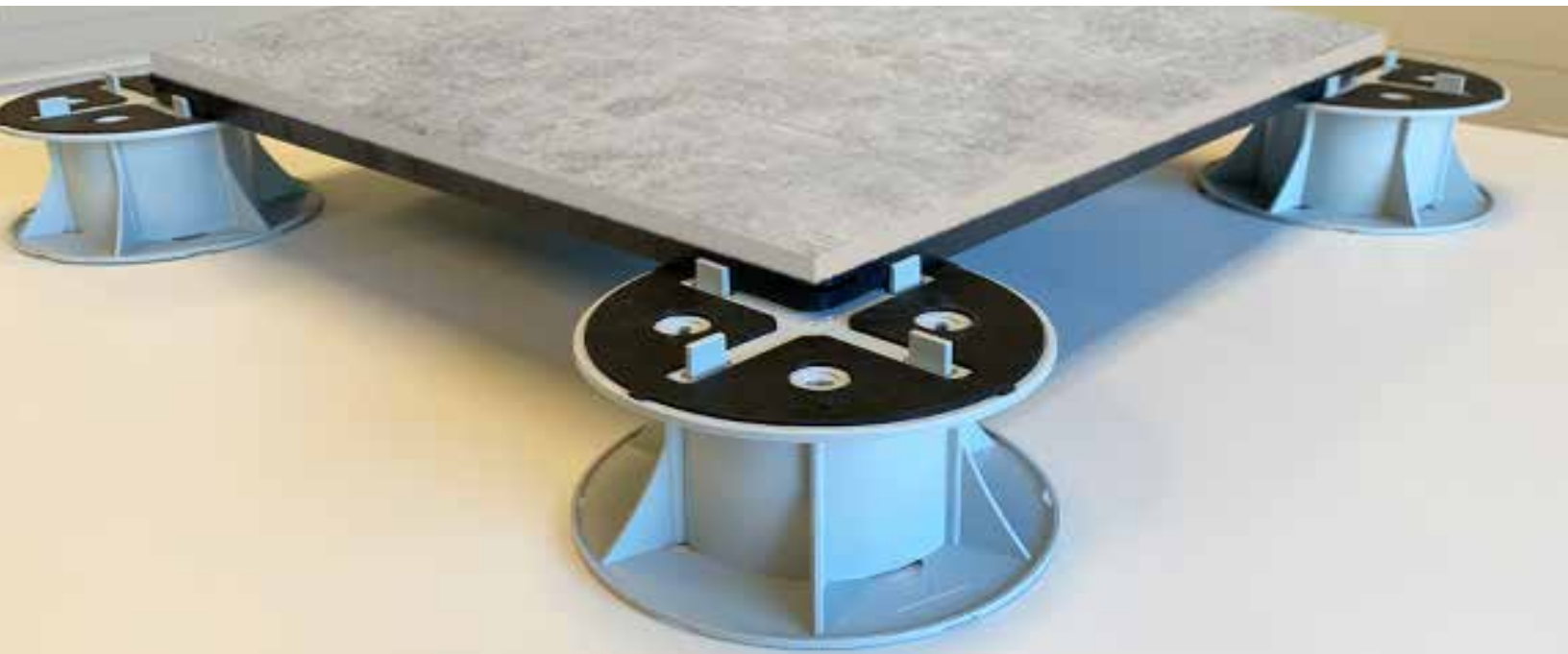

#### MATERIAL

A blend of Nylon 66/6 with approx. 33% glass

#### DIMENSIONS

23.5" x 23.5" x 7/8"

#### WEIGHT

5.5 lbs per grate

#### YIELD STRENGTH

Average yield strength: >15,000 psi

#### ULTIMATE STRENGTH

Ultimate strength: >20,000 psi\*

\*Strength and deflection results are derived from Solidworks Simulation 2020 structural modeling software



## GRO PAVER GRATE FASTENING KIT

GRO Paver Grate Fastening Kit for use with GRO Paver Grates provides a secure connection between pedestals and the pavers on a finished deck surface. The weight of the grates and pavers creates a monolithic system to hold the system in place and mitigate against wind uplift.



### SCREW & WASHER

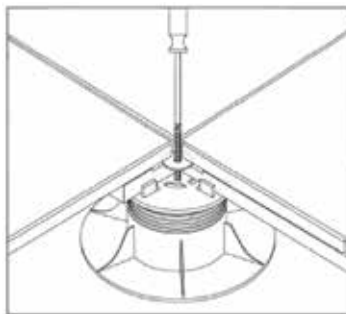

**For pedestal heights > 2.5"**  
**Easily removable for repairs and maintenance**

GRO Paver Grates are engineered with a slot cut in each corner enabling a special washer and finishing screw to be inserted. Once all grates are in place, the washer and screw are invisibly screwed into the corresponding screw pad at the top of the pedestal to "lock down" the grates, ensuring a safe, secure, and level surface. Our fastening kit makes removal of a centrally-located grate simple, and eliminates the need to remove all grates from the perimeter up to that point.

### PLASTIC PINS

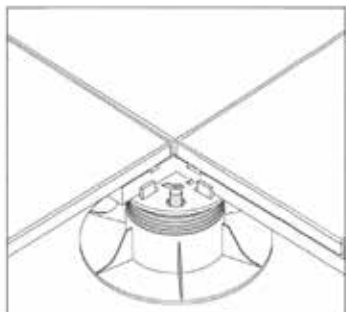

**For pedestal heights < 2.5"**  
**More permanent connection**

GRO Paver Grates have a connection hole in the bottom of grate to secure a plastic pin, which provides a connection to the pedestals. Once all grates are in place, the plastic pins are invisible, and ensure a safe, secure, and level surface. With the plastic pin fastening kit, this connection is more permanent, so if removal is required, the pins must be broken and replaced as needed.

# Deck Pavers & Pedestal Systems





## GRO PEDESTALS

GRO Pedestals work perfectly with all deck pavers, including wood, porcelain, and concrete. We offer both fixed and self-leveling head pedestals that can hold thousands of pounds each. The self-leveling head can cut installation time on sloped roofs! The pedestals help conceal roof extrusions, like anchor points and pipes. GRO Pedestals allow our fastening kit to secure wood and porcelain pavers down to mitigate movement and wind uplift.

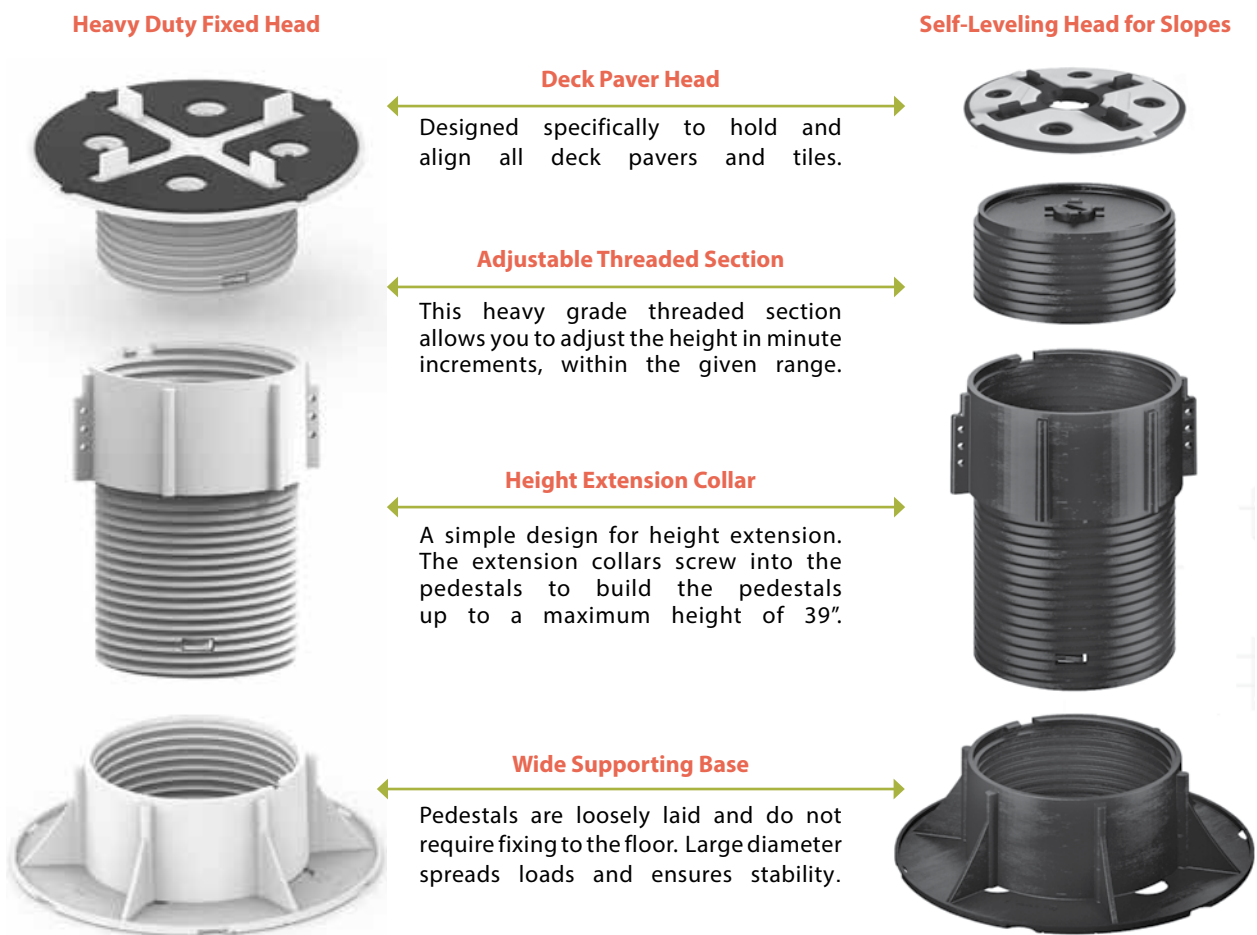

# Artificial Turf



# ARTIFICIAL TURF



## GRO ARTIFICIAL TURF

GRO Artificial Turf is a low maintenance environmentally safe-solution for creating natural looking play and gathering spaces for patios, terraces, and roof top areas. It resists staining, mold and mildew, and is quick drying. As GRO Artificial Turf doesn't require treatment with potentially harmful pesticides and fertilizers and has impact absorbing qualities, it is an ideal surface for playground and pet areas. A MADE IN THE USA product.

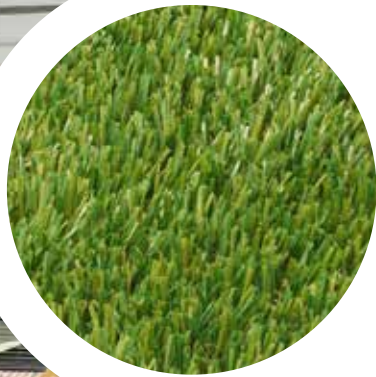

	<u>FACE WT.</u>	<u>PILE HT.</u>	<u>COLOR</u>	<u>THATCH</u>
GRO ZOYSIA SPRING 60	60 oz.	1 3/4"	Field/Apple/Emerald/Blonde	Green and Tan
GRO ZOYSIA SPRING 80	80 oz.	2"	Field/Apple/Emerald/Blonde	Green and Tan
GRO ZOYSIA FALL 60	60 oz.	1 3/4"	Field/Olive/Emerald/Blonde	Green and Tan
GRO ZOYSIA FALL 80	80 oz.	2"	Field/Olive/Emerald/Blonde	Green and Tan
GRO FESCUE 90	90 oz.	1 3/4"	Field and Emerald	Green and Tan
GRO ALL PLAY 55	55 oz.	1 1/8"	Field and Apple	Green and Tan
GRO PUTTING TURF	46 oz.	5/8"	Green	NA
GRO PET TURF	55 oz.	1 1/8"	Field and Apple	Green and Tan
MATERIAL	Polypropylene thermoplastic (PP) blended with Polyethylene (PE) thatching			
USES	Rooftop amenity spaces, playgrounds, pet areas, sports fields, putting greens, balconies, decks, and lawns			
CHARACTERISTICS	Durable - designed for heavy traffic and wear and tear Weatherproof, impact absorbing, mold and fade resistant Low maintenance Offers unlimited design possibilities ADA accessible			
ACCOMPANYING GRO PRODUCTS	GRO PEDESTALS GRO STRUCTURAL GRATE			

# Wind Uplift & Erosion Control







## GRO VEGETATED WIND UPLIFT & EROSION CONTROL KIT

GRO Vegetated Wind Uplift & Erosion Control Kits include a synthetic wind uplift mat, jute erosion blanket, and wind anchors to stabilize and hold in place growing media and plant material on windy rooftops. GRO Wind Anchors are made of recycled polypropylene base disks, retention disks, and connecting shafts. They are easy to install and lightweight. A MADE IN THE USA product.

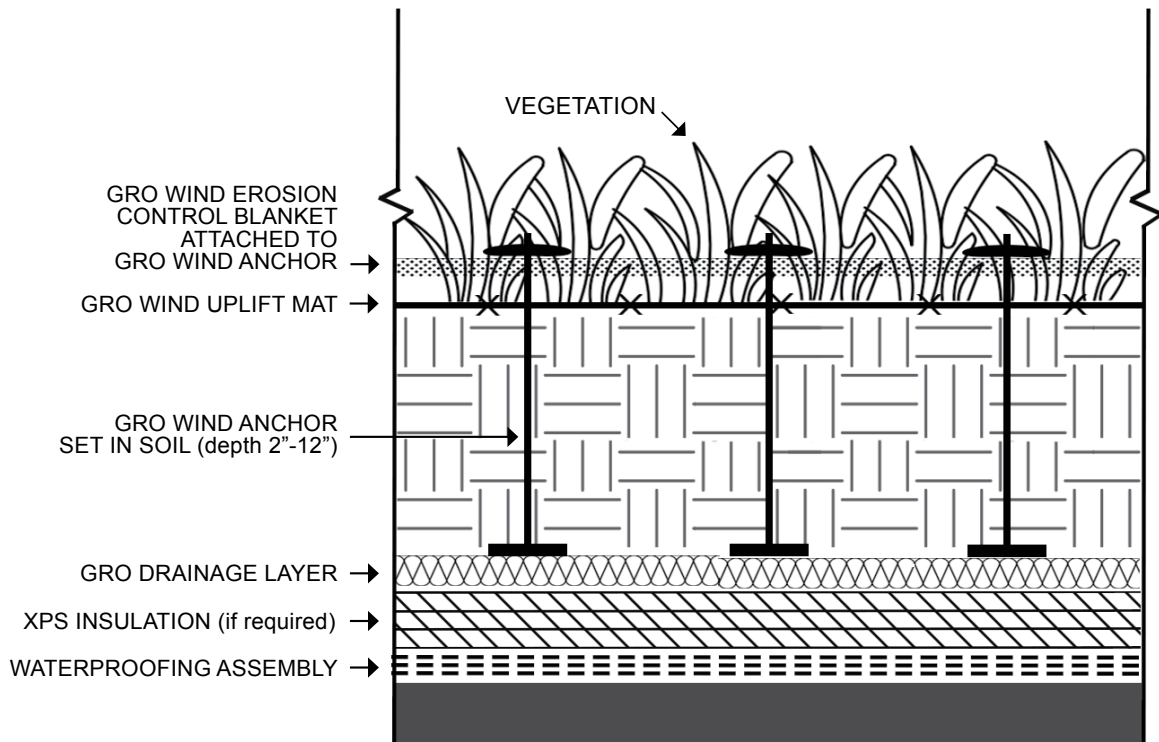

### WIND ANCHOR

**MATERIAL**

Recycled Polypropylene

**DIMENSIONS**

Shaft height = 12"; Adjustable from 2" - 12"

**WIND RESISTANCE**

Retention discs resist pulling from shaft up to 60-100 N of direct force

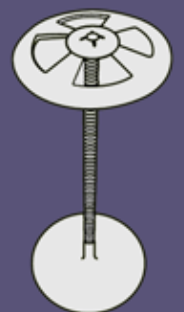

# Wind Uplift & Erosion Control

## EROSION BLANKET & WIND UPLIFT MAT



### WIND EROSION CONTROL BLANKET

GRO Wind Erosion Blanket provides support for green roof plants, protecting them against wind scour as they become established, and stabilizing growing media on windy roof decks. Made of rolled natural jute material, it is an environmentally friendly, biodegradable blanket that allows plants to root through the material into the growing media. Ideally suited for use in conjunction with GRO Wind Anchors and GRO Wind Uplift Mat.

MESH SIZE

1<sup>1</sup>/<sub>16</sub>" x 3<sup>3</sup>/<sub>4</sub>"

THICKNESS

1<sup>1</sup>/<sub>4</sub>"

WATER ABSORPTION

>450% of fabric weight

RECOMMENDED FLOW & SLOPE

6 fps (flow) and 3:1 (slope)



### WIND UPLIFT MAT

GRO Wind Uplift Mat is a high tenacity polyester woven and PVC coated geogrid used to reinforce green roof vegetation and growing media on windy rooftops. It is not susceptible to biological degradation and is resistant to naturally occurring chemicals, alkalis, and acids.

MATERIAL

Multifilament Polyester Yarns coated with PVC

TENSILE ULTIMATE STRENGTH

2,025 lbs/ft (ASTM D6637)

TENSILE CREEP LIMITED STRENGTH

1,341 lbs/ft (ASTM D5262)

LONG TERM DESIGN STRENGTH

1,161 lbs/ft (NCMA 97)

APERTURE SIZE

1" x 7<sup>7</sup>/<sub>8</sub>" (measured)



## BALLAST GRID

### GRO BALLAST GRID

GRO Ballast Grid is a concrete permeable paver grid that provides a strong, yet breathable foundation. It offers excellent erosion control and can be used to mitigate wind uplift in wind zones on roofs. The voids within the grid can be filled with a variety of material; including gravel, soil, turf, and/or plants, depending on the application, to create functional and attractive permeable spaces. It also can be used at ground level as a surface for both pedestrian and low-use vehicular areas. A MADE IN THE USA product.

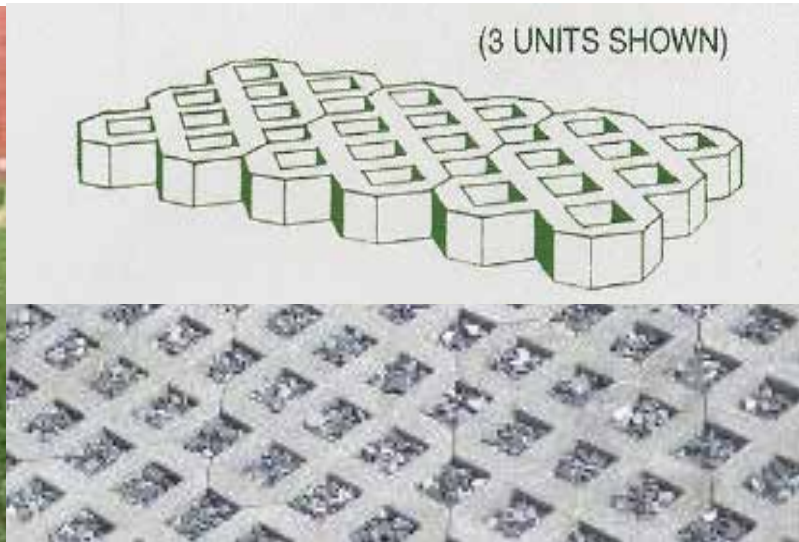

DIMENSIONS (H x W x D)	15 5/8" x 23 7/8" x 3 1/8"
WEIGHT	60 lbs each
APERTURE SIZE	3 5/8" x 3 5/8"
COMPRESSION STRENGTH	5,000 psi
USES	Rooftops, Walkways, and Parking Areas

# Wind Uplift & Erosion Control

## STRUCTURAL GRATE

### GRO STRUCTURAL GRATE

GRO Structural Grates create a stable and secure foundation on pedestals or joists for: artificial turf assemblies, porcelain pavers, modular green roof systems, and planters. They are engineered to attach to the pedestals for stability and wind uplift resistance. Multiple options are available for adhesion to porcelain pavers and these grates provide a solid surface area to support artificial turf installations.



Grate on GRO Pedestals



Grate on GRO Pedestals  
with Artificial Turf



Grate on GRO Pedestals with  
Porcelain Paver with GRO Planter



Grate on GRO Pedestals with GRO  
Vista 4" Module

#### MATERIAL

A blend of Nylon 66/6 with approx. 33% glass

#### DIMENSIONS

23.5" x 23.5" x 1"

#### WEIGHT

5.5 lbs per grate

#### YIELD STRENGTH

Average yield strength: >15,000 psi\*

#### ULTIMATE STRENGTH

Ultimate strength: >20,000 psi\*

\*Strength and deflection results are derived from Solidworks Simulation 2020 structural modeling software



## STRUCTURAL GRATE FASTENING KIT

### GRO STRUCTURAL GRATE FASTENING KIT

GRO Structural Grate Fastening Kit for use with GRO Structural Grates provides a secure connection between pedestals and the finished deck surface. The weight of the grates and the finished deck surface, whether it is artificial turf, a green roof system, planters, or pavers, creates a monolithic system to hold the system in place and mitigate against wind uplift.

#### SCREW & WASHER

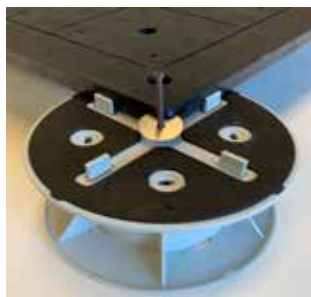
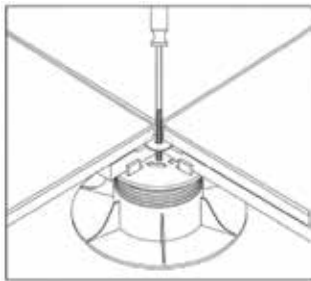

**For pedestal heights > 2.5"**  
**Easily removable for repairs and maintenance**

GRO Structural Grates are engineered with a slot cut in each corner enabling a special washer and finishing screw to be inserted. Once all grates are in place, the washer and screw are invisibly screwed into the corresponding top of the pedestal to "lock down" the grates, ensuring a safe, secure, and level surface. Our fastening kit makes removal of a centrally-located grate simple, and eliminates the need to remove all grates from the perimeter up to that point.

#### **Fastening kit pedestal height > 2.5" installation:**

Three GRO Structural Grates are placed on a pedestal. The screw and washer is placed into the fastening slot of each grate. The fourth grate is placed on the pedestal and the screw is fastened down to lock the structural grates in place.

#### PLASTIC PINS

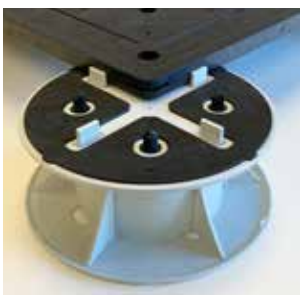
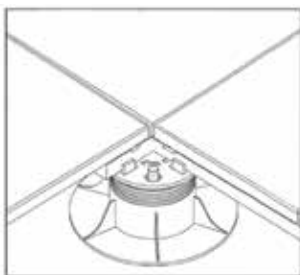

**For pedestal heights < 2.5"**  
**More permanent connection**

GRO Structural Grates have a connection hole in the bottom of grate to secure a plastic pin, which provides a connection to the pedestals. Once all grates are in place, the plastic pins are invisible, and ensure a safe, secure, and level surface. With the plastic pin fastening kit, this connection is more permanent, so if removal is required, the pins must be broken and replaced as needed.

#### **Fastening kit pedestal height < 2.5" installation:**

Align the holes on the underside of the structural grate with the plastic pins in the pedestals. Push down on grates until connection is complete.

# Green Walls & Fences



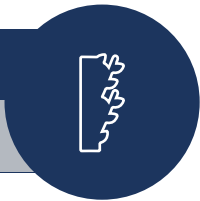

## GRO LIVING WALL

GRO Living Wall is a living green wall system that creates a naturally lush environment, acts as a natural air filter, reduces energy needs for heating and cooling, and mitigates noise levels. The GRO Living Wall system can be free standing or wall mounted for use in either indoor or outdoor spaces. The GRO design team can consult with you to choose which one of our systems works best for your application and budget. A GRO Living Wall system makes an aesthetically stunning statement, qualifies for LEED points, and provides health, economic, and environmental benefits.



MATERIAL	Live plants
DIMENSIONS	Custom sized per project specifications
DESIGN	Panels are customizable and Easy to install
IRRIGATION	Built-in to each system; Highly efficient and effective
CHARACTERISTICS	Improved air quality; Reduces energy consumption Promotes healthy climate; Blocks ambient noise Adds value to property; Increased worker productivity Stormwater mitigation; Encourages biodiversity (outdoor)

# Green Walls & Fences





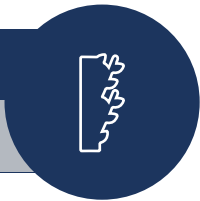

## GRO ARTIFICIAL WALL

GRO Artificial Wall, our artificial green wall system, is the most realistic and highest-quality artificial green wall solution on the market. Designed to mimic the growing patterns and movement of living plants, the effect is natural, seamless, and random, just like real plant foliage, but with no maintenance required! Our artificial green wall panels are easy to install and can be used in either indoor or outdoor spaces. A GRO Artificial Wall is an affordable solution for creating the look of a beautiful vertical garden in the most challenging environments.



MATERIAL	Artificial greenery
DIMENSIONS	32" x 32" panels
WEIGHT	14 lbs per panel
CHARACTERISTICS	Improved air quality; Reduces energy consumption Promotes healthy climate; Blocks ambient noise Adds value to property; Increased worker productivity Stormwater mitigation; Encourages biodiversity (outdoor)

# Green Walls & Fences



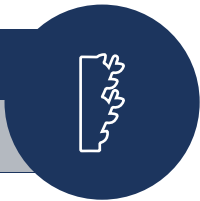

## GRO FENCES

GRO Fences are pre-grown English or Spanish Canary ivy steel fence trellises that arrive ready to install. They are a natural and instant way to create privacy and intimacy in urban and/or commercial environments. GRO Fences can be planted in or above the ground, or between/against buildings, using GRO Fence Planter boxes.

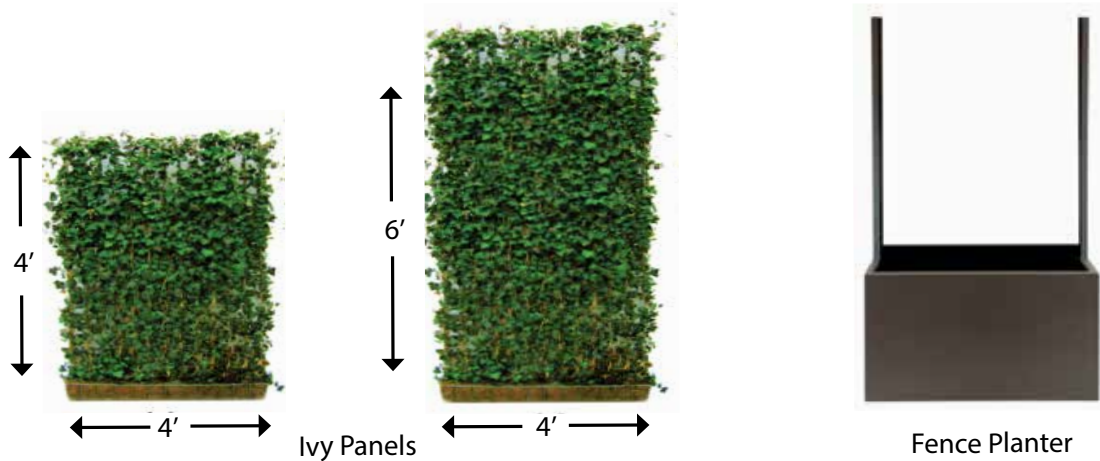

### MATERIAL

English or Spanish Canary Ivy with Galvanized High Carbon Steel Security Fencing

### DIMENSIONS & WEIGHT

4' x 4" x 4" = 33 lbs.  
 4' x 4" x 6" = 50 lbs.  
 Custom sizes available

### CHARACTERISTICS

Simple and quick to install  
 Low maintenance  
 Big impact on small and/or urban spaces

### FENCE PLANTER MATERIAL

Aluminum - (Stainless Steel and Corten Steel available upon request)

### SIZE, WEIGHT, & CAPACITY

54"L x 15"W x 15" H; Alum. 43 lbs. / Steel 119 lbs.; 53 Gal. Capacity  
 54"L x 24"W x 24" H; Alum. 71 lbs. / Steel 197 lbs.; 135 Gal. Capacity

# Planters





## FIBERGLASS

### GRO FIBERGLASS PLANTERS

GRO Fiberglass Planters add style, interest, and gardening spaces to rooftop patios, decks, and green roofs. These planters are extremely durable and require no additional maintenance. Because they are lighter than concrete and stone planters, GRO Fiberglass Planters are easier to install and are ideal for larger plants, shrubs, and screening vegetation. Available in a variety of aesthetic colors, styles, and sizes.



#### SIZES

Variety of standard and custom sizes

#### SHAPES

Squares, rectangles, rounds, and cylinders

#### COLORS

Available in all RAL and custom colors

#### CHARACTERISTICS

High quality finish  
Lightweight  
Weatherproof  
UV protection

# Planters

## RECTANGLES 8" - 42" HEIGHT

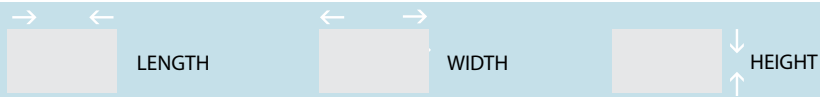

LENGTH	WIDTH	HEIGHT	LIP	WEIGHT (LBS)
42"	8"	8"	1.75"	9
65"	14"	12"	1.25"	35
84"	36"	18"	1.5"	82
54"	8"	18"	2.0"	23
24"	10"	24"	1.25"	18
60"	16"	24"	1.5"	47
100"	18"	28"	1.5"	97
36"	24"	32"	1.5"	85
72"	16"	32"	1.5"	73
36"	16"	42"	1.5"	50

## CUBES 16" - 40" HEIGHT



LENGTH	WIDTH	HEIGHT	LIP	WEIGHT (LBS)
16"	16"	16"	1.5"	12
22"	22"	22"	1.5"	20.5
28"	28"	28"	1.5"	46
32"	32"	32"	1.5"	54
36"	36"	36"	1.5"	68.5
40"	40"	40"	1.5"	88.5

## TALL SQUARES 24" - 60" HEIGHT



LENGTH	WIDTH	HEIGHT	LIP	WEIGHT (LBS)
12"	12"	24"	1.25"	11
16"	16"	32"	1.25"	22
20"	20"	42"	1.25"	45
12"	12"	51"	1"	23.5
16"	16"	60"	1"	40.8



# FIBERGLASS: RECTANGLES, SQUARES, & CUBES

## TAPERED RECTANGLES 18" - 24" HEIGHT

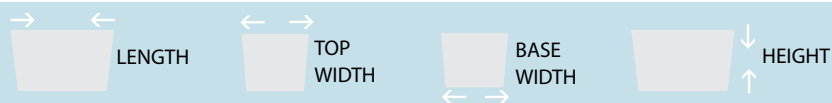

LENGTH	TOP WIDTH	BASE WIDTH	HEIGHT	LIP	WEIGHT (LBS)
36"	12"	10"	18"	1.625"	21
60"	16"	15.5"	24"	1.25"	47.5

## TAPERED CUBES 12" - 24" HEIGHT



TOP WIDTH	BASE WIDTH	HEIGHT	LIP	WEIGHT (LBS)
9.5"	5.5"	12"	1.5"	5.5
13.5"	8"	16"	1.5"	8.5
16.5"	10"	20"	1.5"	13
21"	12"	24"	1.5"	17

## TAPERED SQUARES 22" - 60" HEIGHT



TOP WIDTH	BASE WIDTH	HEIGHT	LIP	WEIGHT (LBS)
12"	9"	22"	1"	10
16"	12"	30"	1"	19.5
18"	14.5"	36"	1"	25.5
20"	19.25"	42"	1"	32
23"	19.25"	48"	1"	26.5
28"	23.5"	60"	1"	68.5

# Planters

## CYLINDERS 20" - 36" HEIGHT



WIDTH	HEIGHT	LIP	WEIGHT (LBS)
10"	20"	1"	6
18"	20"	1"	11.5
22"	22"	1"	16
10"	30"	1"	8
30"	32"	1"	31
12"	36"	1"	11

## ROUND BOWL 18" - 34" HEIGHT



TOP WIDTH	BASE WIDTH	HEIGHT	LIP	WEIGHT (LBS)
15"	9"	17.5"	1"	6.6
30"	12"	20"	3"	21
23"	10"	22"	2"	14.5
20"	13.5"	23"	1.75"	11
36"	15.5"	34"	2"	36
18"	16"	29"	2"	12
27"	17.75"	31"	2"	18

## GLOBE 19" - 31" HEIGHT



TOP WIDTH	MID WIDTH	BASE WIDTH	HEIGHT	WEIGHT (LBS)
13"	24"	16"	18.75"	12.5
17"	36"	20"	30.5"	29.5





# FIBERGLASS: CYLINDERS & ROUNDS

## TAPERED CYLINDERS 26" - 30" HEIGHT



TOP WIDTH	BASE WIDTH	HEIGHT	LIP	WEIGHT (LBS)
18"	14"	26"	2"	9
22"	18"	30"	1.25"	17.5
25.5"	22"	30"	3"	16

## TAPERED ROUNDS 25" - 63" HEIGHT



TOP WIDTH	BASE WIDTH	HEIGHT	LIP	WEIGHT (LBS)
14"	11.375"	25"	1"	9.7
33"	18"	29"	2"	28.6
12"	9"	32"	1"	7
18"	14.75"	32"	1"	16.5
39"	23"	34"	2"	40
24"	18.625"	36"	1.5"	15
16"	11.75"	38"	1"	15
44"	26"	39"	2"	48.5
20"	14.25"	43"	1"	24
30"	25"	63"	1.5"	42

## FISHBOWL 15" - 19" HEIGHT

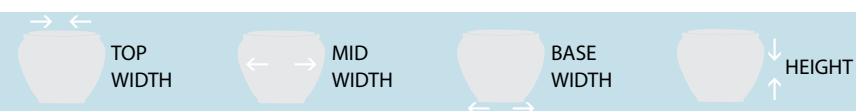

TOP WIDTH	MID WIDTH	BASE WIDTH	HEIGHT	WEIGHT (LBS)
16"	16"	11.25"	15"	6
20.5"	21.5"	15"	19"	17

# Planters





## ALUMINUM | STAINLESS | CORTEN

### GRO METAL PLANTERS

GRO Metal Planters add contemporary style to rooftop patios, decks, and green roofs. These planters are extremely durable and non-corrosive, and their UV-resistant construction makes them fade and chip resistant, even in extreme weather conditions. GRO Metal Planters are crafted with continuous welds, making them leak-proof and safe to place on marble, wood, and other surfaces. Available in variety of aesthetic colors, styles, and sizes to provide a beautiful, contemporary, and luxurious look to outdoor spaces.



*Available colors for aluminum and stainless steel*

MATERIAL	Aluminum (marine grade, recycled 5052 alloy) Stainless Steel (304 or 316) and Corten steel
SIZES	Variety available
SHAPES	Rectangle, cube, tall square, and cylinder
COLORS	Aluminum finishes: brushed, metallic, gloss, matte Custom colors also available
CHARACTERISTICS	Weather and Fade Resistant UV Protected

# Planters

## RECTANGLES 14" - 42" HEIGHT

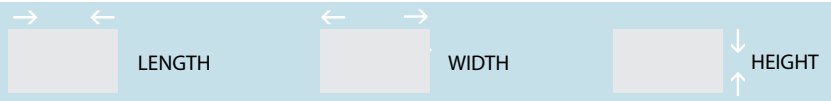

LENGTH	WIDTH	HEIGHT	LIP	WEIGHT (LBS)
25"	14"	14"	1.5"	26
42"	14"	14"	1.5"	35
60"	14"	14"	1.5"	50
42"	18"	18"	1.5"	42
60"	18"	18"	1.5"	58
25"	20"	24"	1.5"	41
42"	20"	24"	1.5"	58
60"	30"	24"	1.5"	72
36"	16"	32"	1.5"	51
46"	16"	42"	1.5"	75

## CYLINDERS 18" - 24" HEIGHT

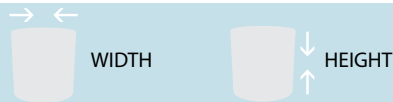

WIDTH	HEIGHT	LIP	WEIGHT (LBS)
18"	18"	Straight Edge	19
24"	24"	Straight Edge	34

## TRIANGLES 24" - 48" HEIGHT



LENGTH	WIDTH	HEIGHT	LIP	WEIGHT (LBS)
36"	36"	24"	1.5"	42
36"	36"	36"	1.5"	57
36"	36"	48"	1.5"	71

\* Weights shown are for aluminum material. Stainless steel and Corten weight available upon request



# METAL: COMMON SIZES SHOWN | CUSTOM SIZES

## CUBES

17" - 28" HEIGHT



LENGTH



WIDTH



HEIGHT



LENGTH	WIDTH	HEIGHT	LIP	WEIGHT (LBS)
17"	17"	17"	1.5"	21
20"	20"	20"	1.5"	28
28"	28"	28"	1.5"	55

## TALL SQUARES

24" - 48" HEIGHT



LENGTH



WIDTH



HEIGHT



LENGTH	WIDTH	HEIGHT	LIP	WEIGHT (LBS)
12"	12"	24"	1"	16
12"	12"	32"	1"	24
12"	12"	40"	1"	28
18"	18"	24"	1.5"	29
18"	18"	36"	1.5"	40
18"	18"	48"	1.5"	49

## TAPERED SQUARES

24" - 40" HEIGHT



TOP  
WIDTH



BASE  
WIDTH



HEIGHT



TOP WIDTH	BASE WIDTH	HEIGHT	LIP	WEIGHT (LBS)
15"	12"	24"	1.5"	20
16"	12"	32"	1.5"	26
17"	12"	40"	1.5"	32





# CONCRETE

## GRO CONCRETE PLANTERS

GRO Concrete Planters, designed for durability, add style to rooftop patios, decks, streetscapes, and green roofs. Scratch and moisture resistant, GRO Concrete Planters are a great option for high traffic areas. Planters are available in a variety of aesthetic colors, styles, and sizes for use in both commercial and residential outdoor spaces.

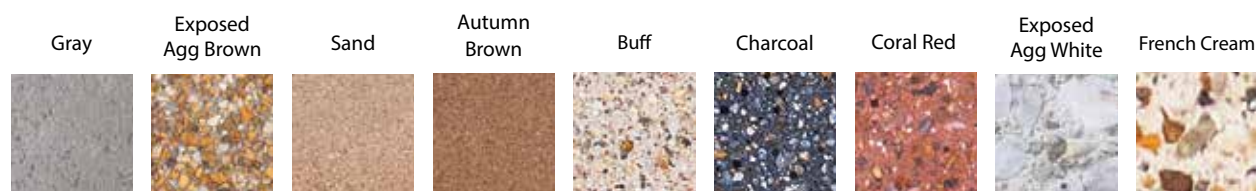

MATERIAL	Cast in Place Concrete
SIZES	Variety available
SHAPES	Rectangle, square, round, and custom shapes available
COLORS	Variety of standard colors / Custom colors also available
CHARACTERISTICS	Durable and Low Maintenance Weather Resistant and Cost Effective

# Planters



**HEIGHT** 26"  
**DIAMETER** 36"  
**WEIGHT (LBS)** 675



**HEIGHT** 22"  
**DIAMETER** 42"  
**WEIGHT (LBS)** 980



**HEIGHT** 24"  
**DIAMETER** 31"  
**WEIGHT (LBS)** 390



**HEIGHT** 18"  
**DIAMETER** 48"  
**WEIGHT (LBS)** 725



**HEIGHT** 24"  
**DIAMETER** 16.25"  
**WEIGHT (LBS)** 210



**HEIGHT** 22"  
**DIAMETER** 36"  
**WEIGHT (LBS)** 650



**HEIGHT** 24"  
**DIAMETER** 36"  
**WEIGHT (LBS)** 775



**HEIGHT** 25"  
**DIAMETER** 29"  
**WEIGHT (LBS)** 683



**HEIGHT** 30"  
**DIAMETER** 48"  
**WEIGHT (LBS)** 1420



**HEIGHT** 30"  
**DIAMETER** 48"  
**WEIGHT (LBS)** 1430





# CONCRETE



**HEIGHT** 30"  
**DIAMETER** 36"  
**WEIGHT (LBS)** 1050



**HEIGHT** 24"  
**LENGTH** 48"  
**WIDTH** 20"  
**WEIGHT (LBS)** 770



**HEIGHT** 24"  
**DIAMETER** 36"  
**WEIGHT (LBS)** 807



**HEIGHT** 34"  
**DIAMETER** 54"  
**WEIGHT (LBS)** 1975



**HEIGHT** 25"  
**SQUARE** 35"  
**WEIGHT (LBS)** 677



**HEIGHT** 18"  
**LENGTH** 48"  
**WIDTH** 24"  
**WEIGHT (LBS)** 620



**HEIGHT** 36"  
**DIAMETER** 48"  
**WEIGHT (LBS)** 2445



**HEIGHT** 36"  
**DIAMETER** 48"  
**WEIGHT (LBS)** 1250



**HEIGHT** 30"  
**LENGTH** 52"  
**WIDTH** 24"  
**WEIGHT (LBS)** 1290



**HEIGHT** 25"  
**SQUARE** 38"  
**WEIGHT (LBS)** 640



Visit our website for a complete library of specifications and product downloads:

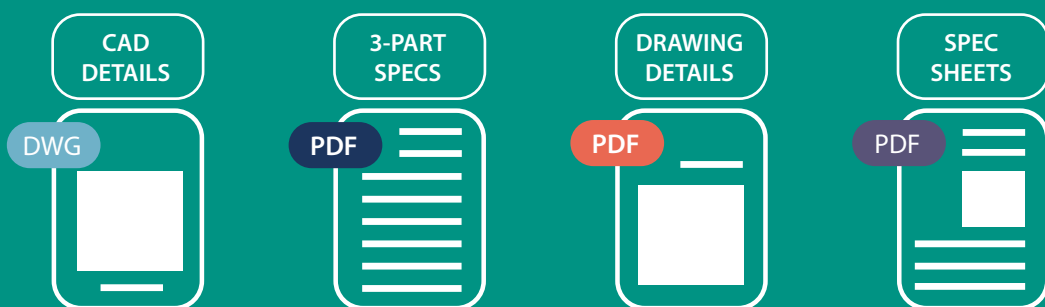



Now offering Accredited  
**AIA CEUs & LA CES courses**  
on our website, by video conference  
or in-office presentations.



# AMENITY DECK PRODUCTS + CONSULTING

[www.greenrisetech.com](http://www.greenrisetech.com)

