

# WESTILE®

TRANSFORMING ROOFTOPS & PLAZAS

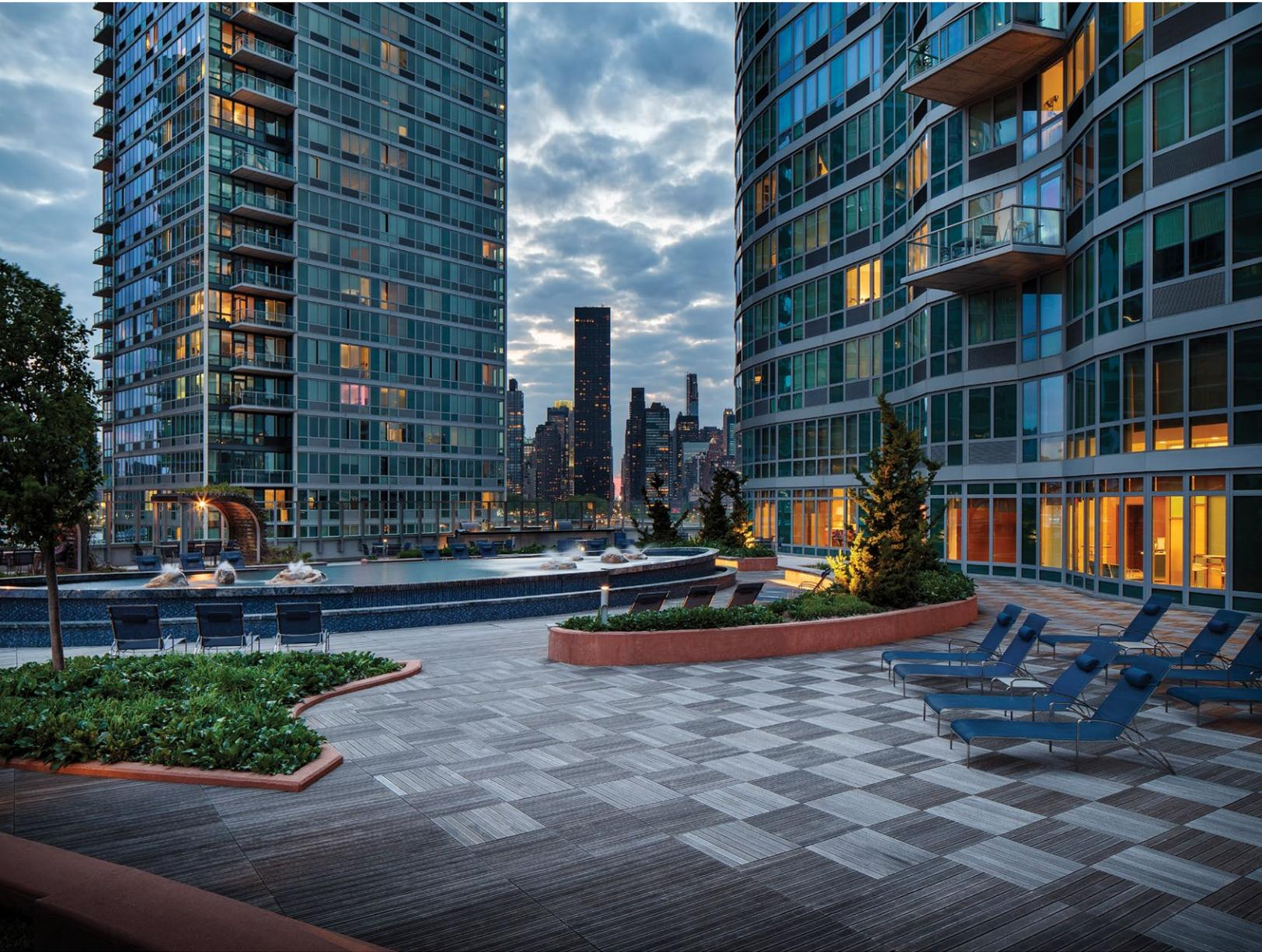

PRODUCT CATALOG



AT WESTILE, WE UNDERSTAND each building structure has its own unique look and style developed with purpose and passion. We share that passion by helping bring that same uniqueness and style to your plaza area. Whether the plaza design is simple or complex, our mission is to assist the architect, building owner and contractor in producing a plaza surface to acheive the look you have envisioned.

**ATTRACTIVE PLAZA AREAS** offer pedestrians an outdoor place to gather and enjoy fresh air, bright sunshine or beautiful views. Plaza decks on rooftops and terraces provide practical solutions for optimizing space and building decks over sloping, difficult or uneven surfaces. Whether the style is traditional or contemporary, Westile's expertise encompasses numerous applications including Schools and Universities, Retail and Office Buildings, Hotels and Restaurants, Government Centers, and Multi-Family or Custom homes.

[WESTILE.COM](http://WESTILE.COM)

# Table of Contents

PRODUCTS .....	4
COLORS & FINISHES .....	12
PRODUCT DETAILS .....	16
ACCESSORIES .....	20
INSTALLATION INSTRUCTIONS .....	22
REFERENCE INFORMATION .....	27



# Products

## CLASSIC PLAZA SLAB

Classic Plaza Slabs are a high-density concrete suited for use as a plaza deck component providing a durable, yet elegant, roof surface. Plaza slabs are elevated on high density polypropylene pedestals, which provide uniform spacing and draining and can achieve a dead level installation if desired.

### DIMENSIONS:

24" x 24" x 1.87" nominal

### WEIGHT:

23 lbs. per square foot

### DIMENSIONAL TOLERANCE:

+/- 1/8" (length, width, height, convex, concave)

### COMPRESSIVE STRENGTH:

8,500 psi per ASTM C140

### WATER ABSORPTION:

less than 5% per ASTM C140

### FLEXURAL STRENGTH:

minimum 725 psi per ASTM C293

### FREEZE THAW:

less than 1% loss in weight after 40 cycles per ASTM C67

Do not use de-icing agents including but not limited to Ammonium Nitrate, Ammonium Sulfate, Sodium Chloride (Salt) and Calcium Chloride; these agents are destructive to Westile pavers.

During the course of the work and on completion, remove any cutting dust from the surface of the pavers by means of water or air. If left unattended, cut dust can and will discolor pavers. When cleaning with high pressure water, use caution to avoid damage to slabs.

Refer to the Plaza Paver Specifications for more information, which is available for download on Westile.com.

## PEDSLAB®

The PedSlab built-in pedestal system is designed to reduce installation labor. The corner pieces allow traditional methods of shimming or leveling, and pedestal edges are relieved to reduce the chance of membrane damage. The 9-pedestal layout gives the PedSlab Pedestal System its unique system.

### DIMENSIONS:

24" x 24" x 2.25" nominal

Pedestal height: 3/8" with 50% of bearing area

### WEIGHT:

96 lbs. per slab

### COMPRESSIVE STRENGTH:

8,500 psi

### WATER ABSORPTION:

less than 5%

### FLEXURAL STRENGTH:

minimum 725 psi

### FREEZE THAW:

less than 1% loss in weight after 40 cycles

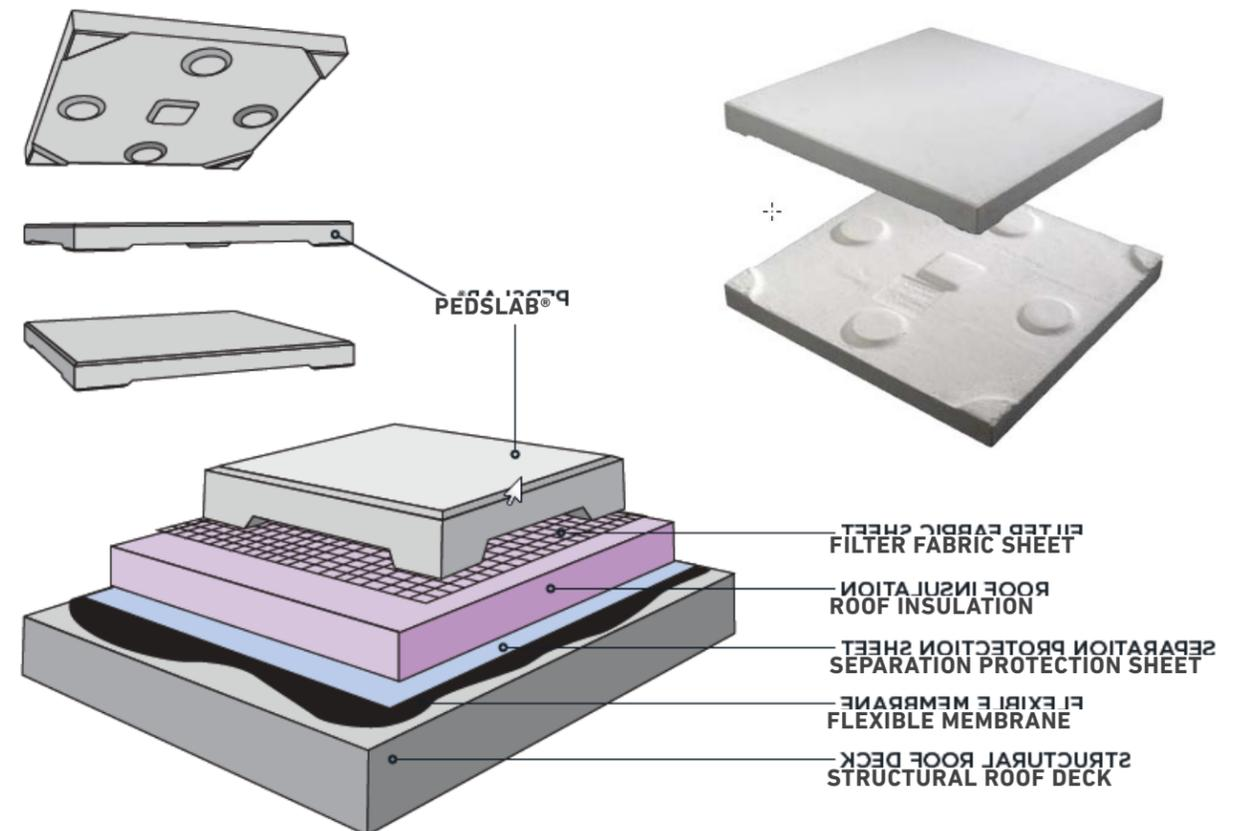

## LIMERICK PLAZA SLAB

Limerick Plaza Slabs are a high-density concrete suited for use as a plaza deck component, providing a durable, elegant roof surface.

Limerick Plaza slabs are elevated on high-density polypropylene pedestals, which provide uniform spacing and draining and can achieve a dead level installation if desired.

### DIMENSIONS:

23.5" x 23.5" x 2" nominal

### WEIGHT:

24 lbs. per square foot

### DIMENSIONAL TOLERANCE:

+/- 1/8" (length, width, height, convex, concave)

### COMPRESSIVE STRENGTH:

minimum 8,000 psi per ASTM C140

### WATER ABSORPTION:

less than 5% per ASTM C140

### FLEXURAL STRENGTH:

minimum 725 psi per ASTM C293

### FREEZE THAW:

less than 1% loss in weight after 40 cycles per ASTM C67

Do not use de-icing agents including but not limited to Ammonium Nitrate, Ammonium Sulfate, Sodium Chloride (Salt) and Calcium Chloride; these agents are destructive to Westile slabs.

During the course of the work and on completion, remove any cutting dust from the surface of the pavers by means of water or air. If left unattended, cut dust can and will discolor slabs. When cleaning with high pressure water, use caution to avoid damage to slabs.

Refer to the Plaza Paver Specifications for more information, which is available for download on [Westile.com](http://Westile.com).

## STONETILE™ SLAB

The StoneTile Slab creates the look of natural stone with an irregular, ridged surface. The natural look is perfect for patios, walkways and poolsides. Available in three classic colors that will complement any outdoor space. Get inspired by the natural beauty of StoneTile Slab.

### DIMENSIONS:

23.62" x 23.62" x 1.57"

### WEIGHT:

78 lbs.

### QTY/PALLET:

28 units

### PALLET WEIGHT:

2,225 lbs.

### COMPRESSIVE STRENGTH:

8,000 psi per ASTM C140

### WATER ABSORPTION:

5% per ASTM C140

### FLEXURAL STRENGTH:

725 psi per ASTM C293

### FREEZE THAW:

1% loss of dry weight per ASTM C67

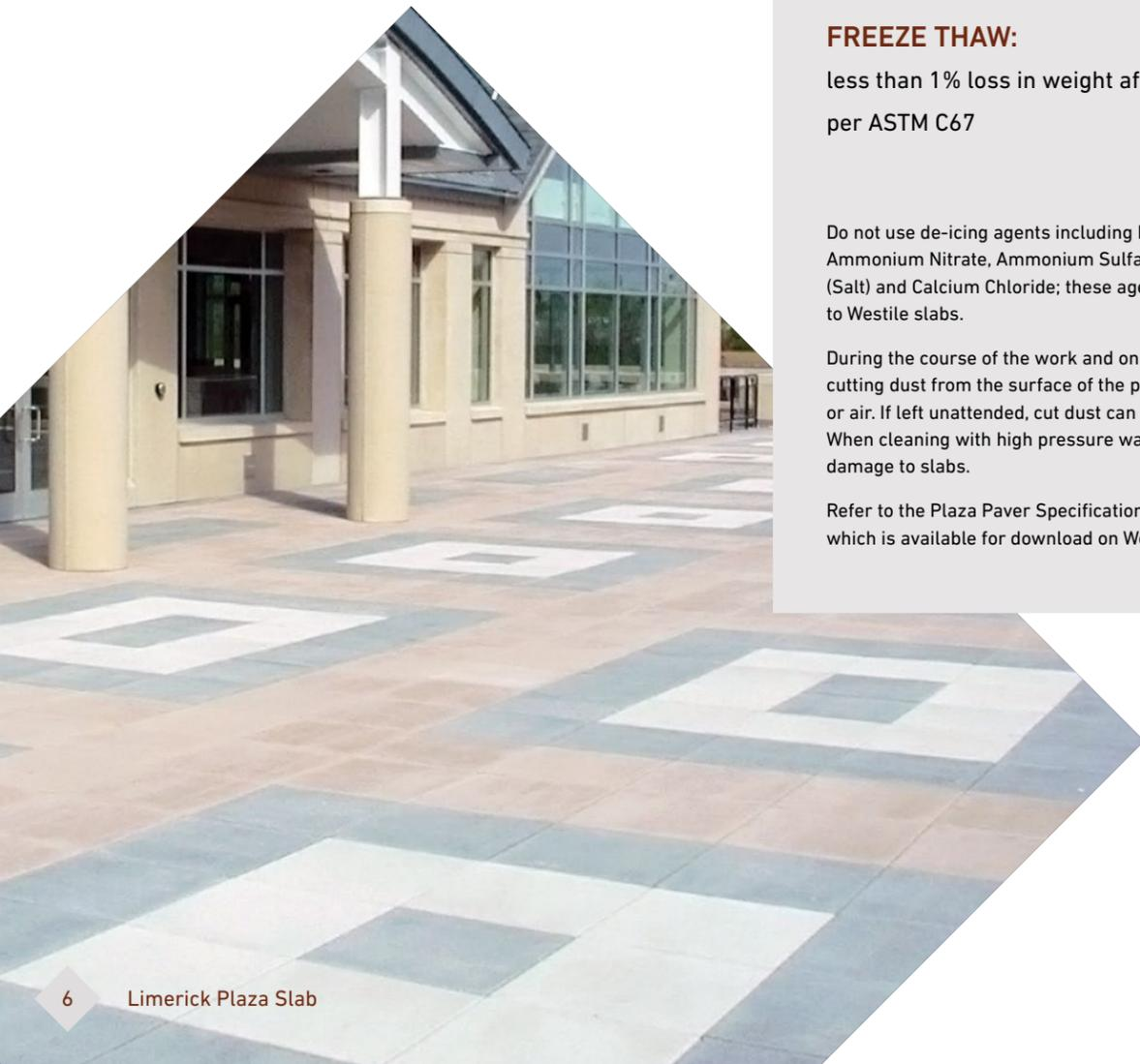

## SMARTCAST DIAMOND SLAB

The high flexural strength of the SmartCast Diamond Slab enables the production of large-format modules. The pavers are diagonally grooved with a non-skid finish. The optimal 40 mm thickness serves to minimize loads on buildings. The pavers are specifically designed to be installed safely on pedestals and to withstand a live load of 660 lb. SmartCast Diamond Pavers may also be used in any applications on a granular base, such as sidewalks, outdoor facilities, pedestrian walkways, etc.



### DIMENSIONS:

23.62" x 23.62" x 1.57"

### WEIGHT:

79 lbs.

### QTY/PALLET:

28 units

### PALLET WEIGHT:

2,212 lbs.

### COMPRESSIVE STRENGTH:

8,000 psi per ASTM C140

### WATER ABSORPTION:

5% per ASTM C140

### FLEXURAL STRENGTH:

725 psi per ASTM C293

### FREEZE THAW:

1% loss of dry weight per ASTM C67

## BALLAST PAVERS

The Ballast Rooftop Pavers are designed to prevent uplift from high winds. These high-density concrete pavers provide a consistent, evenly distributed weight from wind uplift and damage. Additionally, Ballast Pavers also protect the roof system from UV degradation, thermal shock and impact from hail or other falling objects.

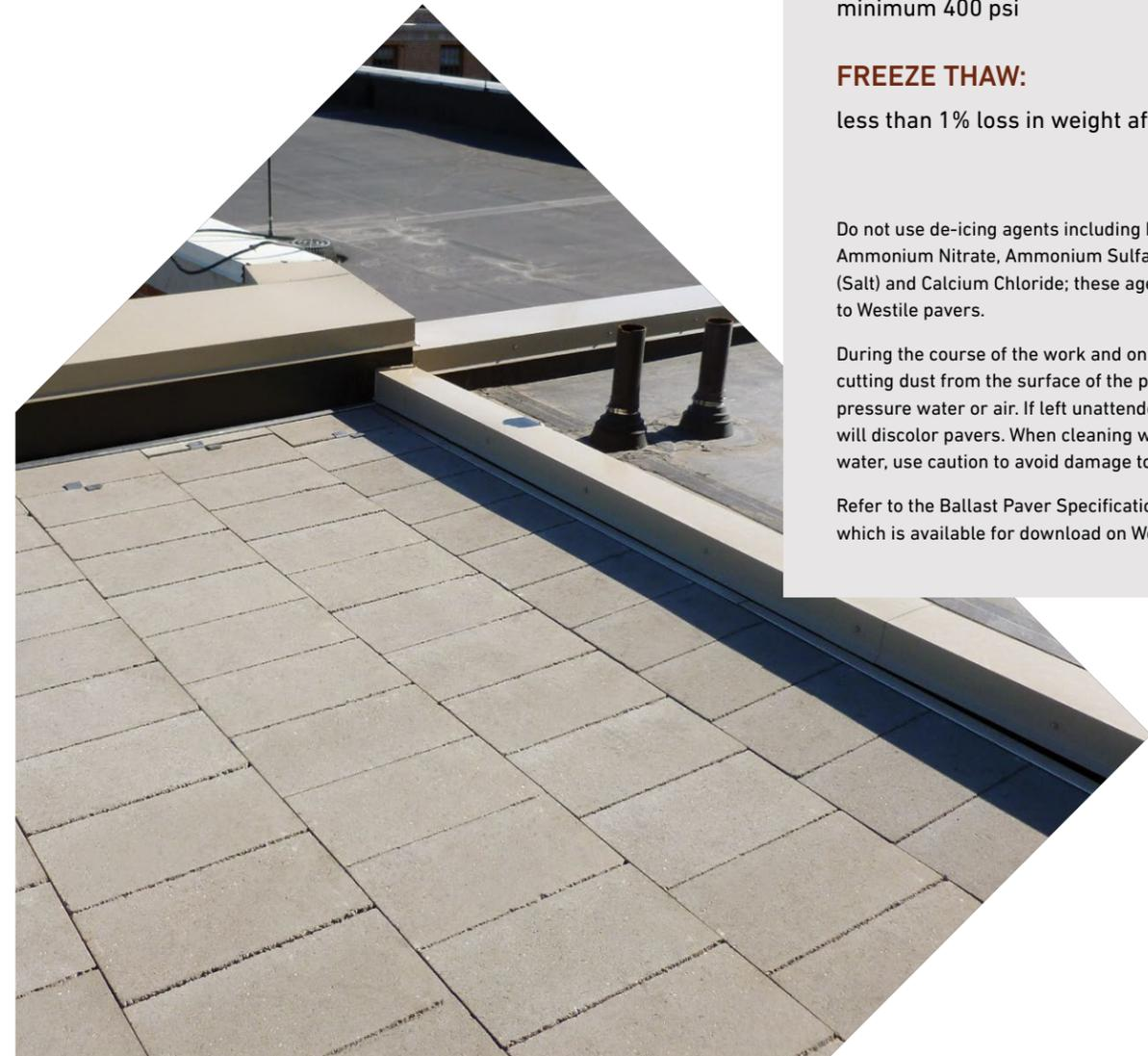

### DIMENSIONS:

8.5" x 16" x 1.625"  
(exposed surface area)

### WEIGHT:

13.75 per square foot

### DIMENSIONAL TOLERANCE:

+/- 1/8" (length, width, height, convex, concave)

### COMPRESSIVE STRENGTH:

minimum 5,000 psi per ASTM C140

### WATER ABSORPTION:

less than 5% per ASTM C140

### FLEXURAL STRENGTH:

minimum 400 psi

### FREEZE THAW:

less than 1% loss in weight after 40 cycles

Do not use de-icing agents including but not limited to Ammonium Nitrate, Ammonium Sulfate, Sodium Chloride (Salt) and Calcium Chloride; these agents are destructive to Westile pavers.

During the course of the work and on completion, remove any cutting dust from the surface of the pavers by means of high pressure water or air. If left unattended, cut dust can and will discolor pavers. When cleaning with high pressure water, use caution to avoid damage to pavers.

Refer to the Ballast Paver Specification for more information, which is available for download on [Westile.com](http://Westile.com).

## WOOD PLAZA PAVERS

Wood Plaza Pavers are an untreated, low maintenance, natural product made from either Cumaru, Mahogany, Bamboo or Ipe wood. All wood options are known for their high density, strength, durability and resistance to decay and insects. Depending on climatic conditions, Wood Plaza Pavers will develop an aged patina and faded coloring as they age. The ends of the wood tiles are sealed with wax at the factory to prevent splitting. Additional cuts made in the field should be sealed. Wax on ends can bleed into wood and be visible, but should become less noticeable over time.



### DIMENSIONS:

23.88" x 23.88" x 1.69"  
23.88" x 47.88" x 1.69"

### WEIGHT:

5.56 lbs per square foot

### SURFACE:

Smooth

### FIRE RATING:

Class A (ASTM E 108-07a Spread of Flame)

### COLOR:

Brown (natural variations to be expected)

### JANKA HARDNESS RATING:

Ipe = 3,680 lbf  
Cumaru = 3,540 lbf  
Massaranduba = 3,190 lbf  
Mahogany = 800 lbf  
Bamboo = 3,850 lbf

### FSC® Certified Available (FSC-C131838)

### Cleaning, Sealing, Staining:

If desired, Wood Pavers can be periodically cleaned, stained and sealed. Before applying any finish, first clean and remove any residue or excess wax from the wood paver. The following manufacturers offer products specifically designed for use with tropical hardwoods: Cabots, Penofin, Messmers.

## CUBES & CUBE TOPS

These popular powder-coated aluminum and Ipe wood cubes provide a great way to add accents to commercial plazas. Each powder-coated aluminum or Ipe wood cube can be used as a stand-alone accent, as a planter, or combined for a multidimensional look. Made of 100% natural wood, the Ipe cubes are eco-friendly and resistant to mold, fire, weather and pests. You can also add a cube top to create bench seating and storage. The choice is yours!

### Powder-Coated Aluminum Cubes

#### COMMON DIMENSIONS:

24" L x 24" W x 20" H  
24" L x 24" W x 36" H  
48" L x 24" W x 20" H  
48" L x 24" W x 36" H

#### MATERIAL:

Recycled raw material content (40% minimum)

### Ipe Wood Cubes

#### COMMON DIMENSIONS:

24" L x 24" W x 16½" H  
48" L x 24" W x 16½" H

#### MATERIAL:

Hardwood harvested sustainably from Brazilian Forests

All Cubes and Tops are made to order.

Custom sizes and colors are available. Contact your Westile representative for more information.

Cube Top



Aluminum

Ipe Wood

# Colors & Finishes

## Standard (Smooth)



5501 | Natural



5502 | Red



5503 | Cinnamon



5504 | Charcoal



5505 | Coral



5506 | Ginger



5508 | Burgundy



5509 | Chamois



SRI White\*

## Shot Blast



Cinnamon



Limestone



Natural



SRI White\*



Chamois



Charcoal



Ginger



Red

\* SRI Color - Solar Reflective Index in Excess of 80

**NOTICE:** Colors subject to change without prior notice. Colors in this brochure may vary from current stock. Actual samples are available from Westile. Slight variations in color may occur during manufacturing. Slight scuffing may occur during handling.

## Diamond (Only available in Eastern U.S.)

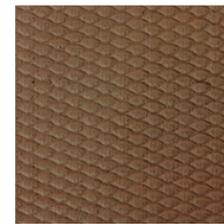

Cinnamon

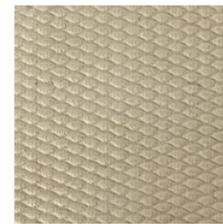

Limestone

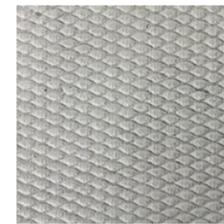

Natural



SRI White\*



Chamois

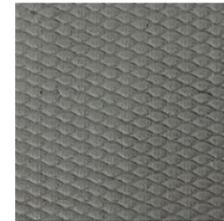

Charcoal

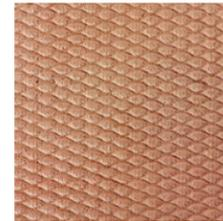

Ginger

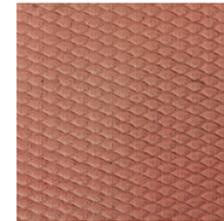

Red



Brooklyn

## Matte



Cinnamon



Limestone



Natural



SRI White\*



Chamois



Charcoal



Ginger



Red

## Wood Pavers



Massaranduba Ribbed



Smooth Cumaru



Smooth Ipe



Mahogany



Bamboo

## Porcelain Pavers

For more product information, contact your Westile representative.



**Turin  
Rapids**



**Turin  
Stream**



**Turin  
Canyon**



**Turin  
Frost**



**Verona  
Blue Stone**



**Verona  
Platinum**



**Verona  
Taos**



**Verona  
Yukon**

## StoneTile™ Slab Colors



**Range Grey**



**Range Black**



**Range Beige**

## Cube Colors



**Red**



**Black**



**White**



**Charcoal**



**Silver**



**Bronze**



**COLOR &  
TEXTURE  
VARIETY**

# Product Details

PLAZA ROOFTOP SLABS & PAVERS														
PRODUCT NAME	MATERIAL	PAVER THICKNESS (NOMINAL)	SIZE (NOMINAL)	APPLICATIONS					FINISHES				PIECES PER PALLET	SQ. FT. PER PALLET
				Pedestrian	Rooftops & Plazas	ADA	Roof Protection	Manual Installation	Standard/Smooth	Diamond	Matte	Shot Blast		
Classic Utility Slabs	Concrete	2"	24" x 24"	✓	✓	✓	✓	✓		✓	✓		25	100
Classic Plaza Slabs	Concrete	2"	24" x 24"	✓	✓	✓		✓		✓	✓	✓	24	96
Classic Plaza Slabs	Concrete	2"	12" x 24"	✓	✓	✓		✓		✓	✓	✓	48	96
Classic Plaza Slabs	Concrete	2"	24" x 36"	✓	✓	✓		✓		✓	✓	✓	24	144
Limerick Plaza Slabs	Concrete	2"	24" x 24"	✓	✓	✓		✓	✓	✓			22	88
StoneTile Slabs	Concrete	1.6"	24" x 24"	✓	✓	✓		✓	✓				28	
SmartCast Diamond Slabs	Concrete	1.6"	24" x 24"	✓	✓	✓		✓		✓			28	
Ballast Rooftop Pavers	Concrete	1.6"	8.5" x 16"				✓	✓	✓				200	189
Wood Plaza Pavers	Wood	1.5"	24" x 24"	✓	✓	✓		✓	✓				44	176
Wood Plaza Pavers	Wood	1.5"	24" x 48"	✓	✓	✓		✓	✓				22	88
Porcelain Pavers	Porcelain	0.75"	24" x 24"	✓	✓	✓		✓	✓				60	233

NOTICE: Check with your Westile Representative for product availability.

# Product Details

SCREWJACK PEDESTALS & ACCESSORIES			
PRODUCT NAME	PRODUCT DESCRIPTION	PIECES PER BOX	MINIMUM QTY
HD25	¼" Fixed Height	100	1 Box
HD50	½" Fixed Height	100	1 Box
HD75	¾" Fixed Height	100	1 Box
B1 ScrewJack	1¼" - 2" Adjustable	30	1 Box
B2 ScrewJack	2" - 3" Adjustable	30	1 Box
B3 ScrewJack	3" - 4¾" Adjustable	30	1 Box
B4 ScrewJack	4¾" - 7¾" Adjustable	30	1 Box
C4 Couple	Adds 2½" - 4" to B3 & B4 Pedestals	30	1 Box
LD4	¼" per foot slope compensator	30	1 Box
B11	⅛" Shim	50	1 Box
PS1	⅛" Shim	50	1 Box
FIB	Weight distribution plate	Each	1 Piece

**NOTICE:** Check with your Westile Representative for product availability.

MODULAR BENCHES & CUBES			
PRODUCT NAME	COMMON SIZES (CUSTOM SIZES AVAILABLE)	COLORS (CUSTOM COLORS AVAILABLE)	MINIMUM QTY
Powder-Coated Aluminum Cube	24"L x 24"W x 20"H	Red, Black, White, Charcoal, Silver	1
Powder-Coated Aluminum Cube	24"L x 24"W x 36"H	Red, Black, White, Charcoal, Silver	1
Powder-Coated Aluminum Cube	48"L x 24"W x 20"H	Red, Black, White, Charcoal, Silver	1
Powder-Coated Aluminum Cube	48"L x 24"W x 36"H	Red, Black, White, Charcoal, Silver	1
Ipe Cube	24"L x 24"W x 16.5"H	Brown (Natural variations occur)	1
Ipe Cube	48"L x 24"W x 16.5"H	Brown (Natural variations occur)	1
Ipe Top	24" x 24"	Brown (Natural variations occur)	1
Ipe Top	48" x 24"	Brown (Natural variations occur)	1

**NOTICE:** All cubes and tops are made to order.



# Accessories

## SCREWJACK PEDESTALS

Possibilities are endless when designing and building plaza decks using ScrewJack Pedestals. The ScrewJack system's elevation range of 1/8" - 36" allows for building plaza decks over almost any sloping or difficult surface.

Building plaza decks over occupied space has never been easier. The unique screw-to-adjust feature eliminates tedious and time-consuming installation often associated with constructing level decks over sloping surfaces. Construction crews quickly level each plaza paver by turning the pedestal base, even while loaded.

Future access to waterproofing entails simply removing specific plaza pavers. ScrewJack adjustments within the allowed range are accomplished by merely turning the pedestal base and you're done – saving time and money.

### SPECIFICATIONS

- Supports up to 1,000 lbs. (FS3)
- Maximum elevation up to 36" using couplers and braces
- Impervious to water, mold & freeze-thaw
- Preassembled
- Packaged in weather-resistant boxes
- Made in the USA
- Contains 20% post-industrial recycled material
- Engagement "bumps" warn of over-extension

### RESOURCES AVAILABLE ON WESTILE.COM

- CAD details
- Specifications
- Technical cut sheets
- Maintenance guide
- Videos: planning, installation & more
- Take-off assistance
- Samples available
- Technical assistance
- Customer service



## ScrewJack Adjustable Pedestals



**Model B1**  
Adjusts from 1 1/4" - 2"  
with 3/16" spacer tab



**Model B2**  
Adjusts from 2" - 3"  
with 3/16" spacer tab



**Model B3**  
Adjusts from 3" - 4 3/4"  
with 3/16" spacer tab



**Model B4**  
Adjusts from 4 3/4" - 7 3/4"  
with 3/16" spacer tab



**Model C4**  
Coupler adds 2 1/2" - 4"  
in height to B3 & B4

## ScrewJack Accessories



**Model LD4**  
Provides 0" - 1/4"  
slope compensation



**Model B11**  
Shim adds 1/16" for fine  
tune adjustment



**Model PS1**  
Shim adds 1/8" for fine  
tune adjustment



**Model HD25**  
Fixed 1/4" height with  
3/16" spacer tab



**Model HD50**  
Fixed 1/2" height with  
3/16" spacer tab



**Model HD75**  
Fixed 3/4" height with  
3/16" spacer tab

## Accessories



**Model B1**  
Adjustable from  
15" - 24"



**VT316**  
Ultra Low Height 3/16"  
Tab - 4 5/8" Diameter

# Installation Instructions

## LEVEL SYSTEM

The *Level System* is used for a dead level paver surface. This system allows for installation of a level paver surface over various sloping substrates.

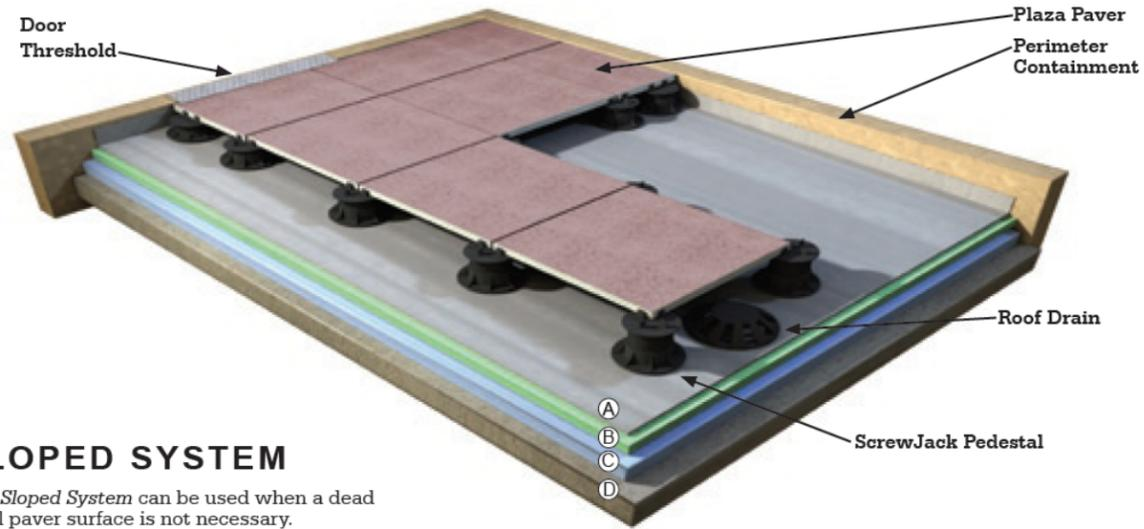

Conventional or IRMA Roof Assembly  
Pedestrian use only

## SLOPED SYSTEM

The *Sloped System* can be used when a dead level paver surface is not necessary.

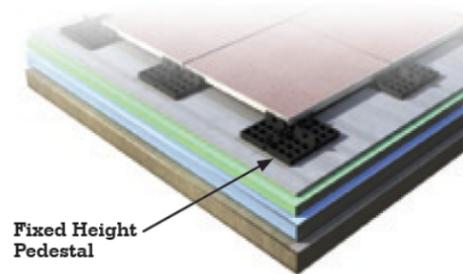

- Ⓐ Membrane
- Ⓑ Protection Board (optional)
- Ⓒ Insulation (optional)
- Ⓓ Roof Deck

Pedestals are loose-laid and not attached to the roof assembly. If insulation is used, refer to the Insulation Manufacturer for p.s.i. requirements.

## SLOPE LEVELING MODEL LD4 EXAMPLE

LD4 Bottom Leveler Disk offers a simple and cost effective solution to compensating for sloping surfaces between 1/4" to 1" per foot of slope. A single LD4 corrects 1/4"; stack up to four as needed.

When using two or more LD4's, rotate in relation to each other to create a plumb ScrewJack and level top surface.

LD4 is not required for slopes under 1/4" per foot.

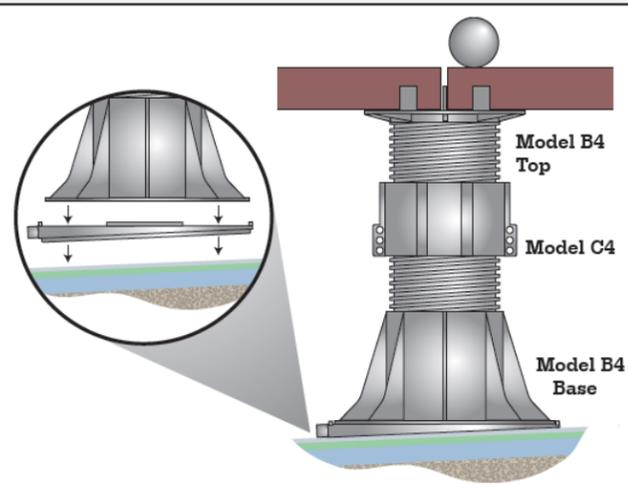

## 1 A TYPICAL PAVER/SCREWJACK INSTALLATION

Refer to the *Westile, Inc. ScrewJack B-Series Specifications*, available for download on [www.westile.com](http://www.westile.com), for complete specification and installation requirements.

### Installation

Do not install first row of pavers at perimeter wall; begin installation of *full* pavers at the second row in the roof field.

Mark perpendicular guidelines on substrate surface to ensure square layout.

Install initial pavers along guidelines forming a "T" pattern.

Install remaining field pavers out from "T".

Install *perimeter* pavers last. Perimeter pavers are normally cut and less than full size to ensure proper layout and fit.

### Door Threshold

### Perimeter Containment

Any section of the roof that receives concrete pavers that is not restrained by an abutting wall or parapet must be "boxed in" by some field installed restraint. No movement should be allowed at the perimeter of a paver system greater than 3/16 inch.

### Perimeter/Corner ScrewJack Installation

For ScrewJack placement at perimeter edges and corners, spacer tabs are easily removed.

Along perimeter, remove two tabs.

At corner, remove all four tabs.

Use all tabs for field pavers.

ScrewJacks at perimeter and corners are installed flush to wall. Base flange can be trimmed for close fit at perimeter.

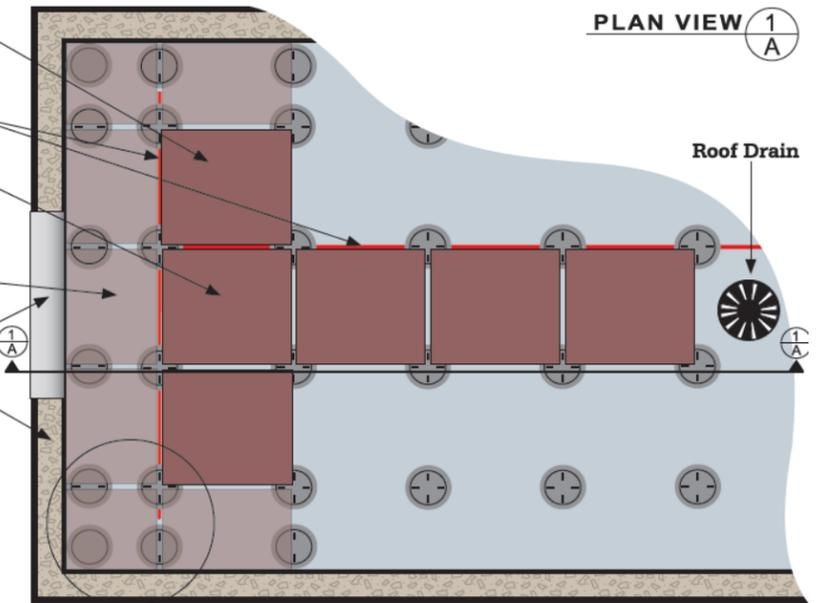

## SCREWJACK SELECTION/ELEVATION

Installation requirements vary for each individual project site. Paver size, pattern, grid layout, starting point and finished deck surface elevation should be shown on shop drawings which have been approved by the designer, installing contractor and owner. Measurements from the construction site should be used for final ScrewJack selection and purchasing.

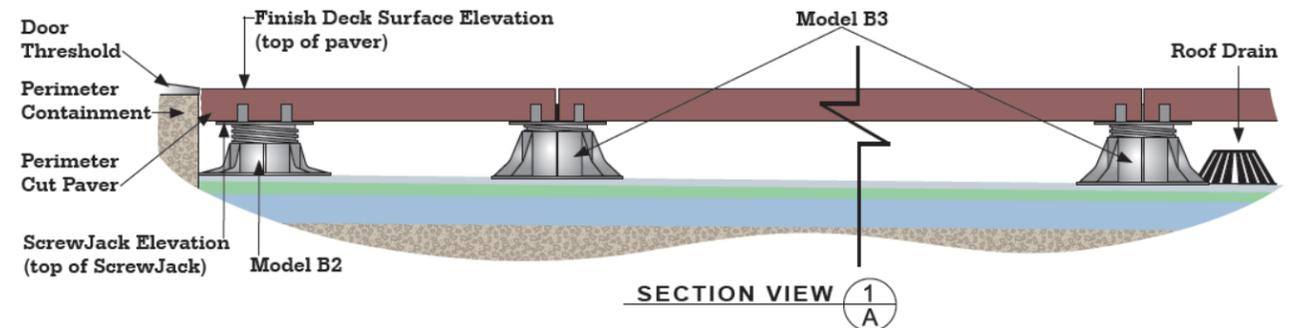

The **Finish Deck Surface Elevation** is determined at the door threshold. The shortest ScrewJacks are usually at the door threshold and the tallest ScrewJacks are at the roof drains. To obtain *ScrewJack Elevation*, subtract paver thickness from the *Finish Deck Surface Elevation*.

For **ScrewJack Elevations below 1 1/4 inch**, use the Fixed Height stackable pedestals, Models PS8 and PS9, or stack B11, 1/16" shims (up to 1/2") plus 3/16" spacer tab.

For **heights above 7 3/4 inches**, use Model C4 coupler with Models B3 or B4. Heights between 16 to 24 inches require additional bracing for extra stability. Contact Westile for specifications.

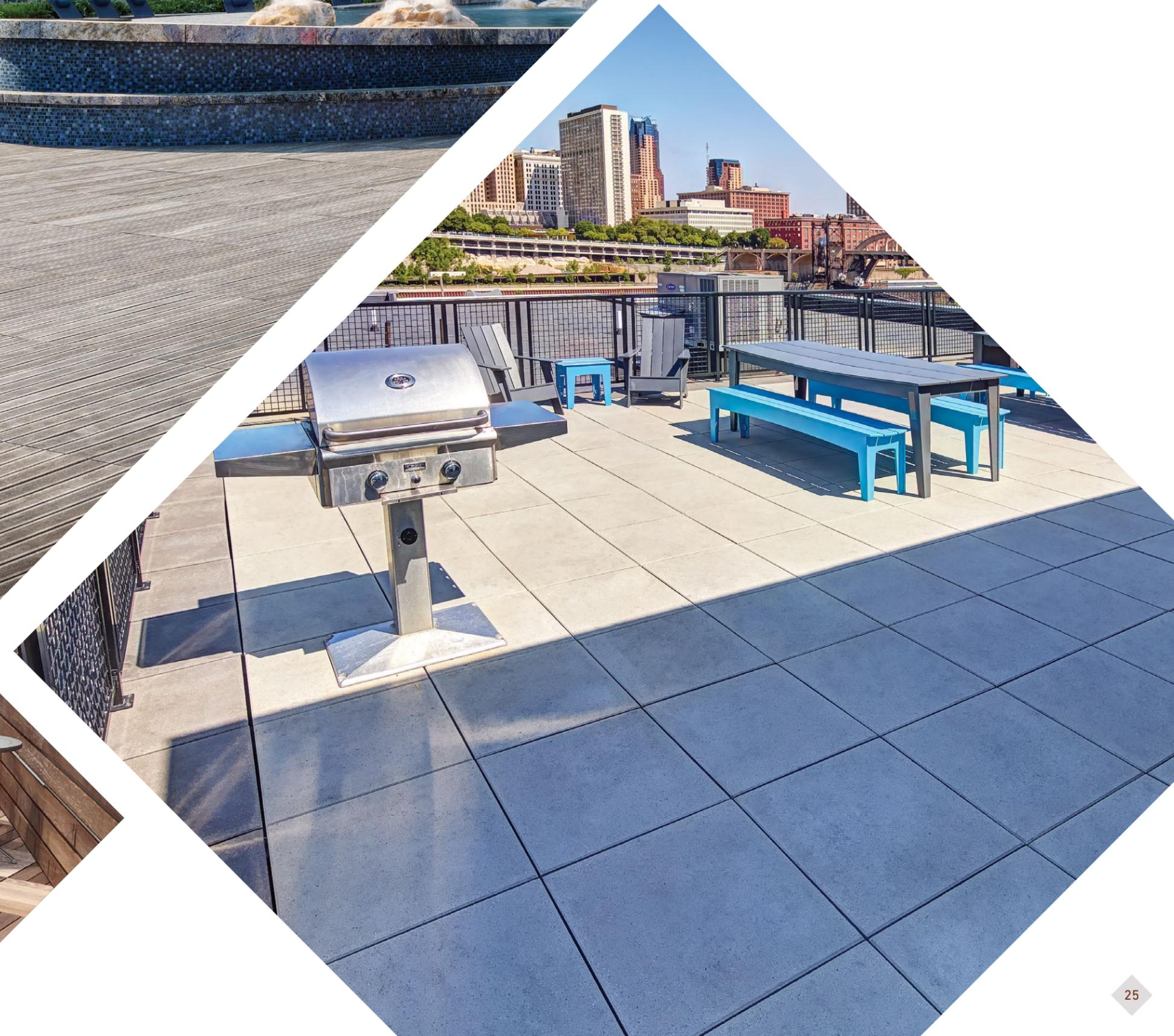



## REFERENCE INFORMATION

### PRODUCT STANDARDS

Westile plaza pavers pass the compressive strength minimum of 8,000 psi as tested in accordance with ASTM C140, freezing and thawing resistance with a maximum 1% loss as tested in accordance with ASTM C67, and flexural strength minimum of 725 psi as tested in accordance with ASTM C293.

### COLOR AND TEXTURE INFORMATION

Due to the inherent nature of concrete, variations in color and textures can and should be expected. In order to obtain optimal plaza deck appearance, it is recommended that care should be taken when installing Westile plaza pavers. Though color and swatch photography in this brochure are as close as possible to the actual plaza pavers, prior to ordering, please contact your Westile representative, and we will gladly provide you with a paver sample of the color(s) you have chosen.

### GREEN BUILDING AND SUSTAINABILITY

Some Westile colors as noted on pages 10 - 11 have a standard solar reflective index (SRI) in excess of 80 which will help meet most requirements for low slope roof energy efficiency. Our white solar reflective plaza pavers provide outstanding durability while helping to reduce interior heat gain and cooling loads as well as assisting to reduce heat island effect.

### EFFLORESCENCE

As moisture evaporates, it leaves salt behind which forms a deposit and can affect the appearance. These deposits can normally be brushed off or will go away with normal weathering. Since efflorescence brings out salts that are naturally occurring part of the concrete and is a temporary occurrence that impacts aesthetics only and does not impact structural integrity.

### WARRANTY

A 10-year limited material warranty is offered on concrete pavers. A 5-year limited warranty is offered on wood pavers and pedestals. Please contact us for warranty information.

### INSTALLATION

For more information regarding the recommended installation of Westile plaza pavers, please contact your local Westile representative.

### CONTACT US

To find local local Westile representative contact us at (800) 433-8453, [info@westile.com](mailto:info@westile.com) or online at [Westile.com](http://Westile.com).

We can provide CEU courses and Lunch & Learn presentations.

Westile, an Oldcastle Company  
5909 Baker Road, Suite 550  
Minnetonka, MN 55345  
(800) 433-8453

[westile.com](http://westile.com)